

Markov models of internet traffic and a new hierarchical MMPP model[☆]

L. Muscariello^a, M. Mellia^a, M. Meo^a, M. Ajmone Marsan^{a,*}, R. Lo Cigno^b

^aPolitecnico di Torino, Dipartimento di Elettronica, Corso Duca degli Abruzzi 24, I-10129 Torino, Italy

^bUniversità di Trento, Dipartimento di Informatica e Telecomunicazioni, Via Sommarive 14, I-38050, Poro, Trento, Italy

Received 30 September 2004; revised 21 February 2005; accepted 21 February 2005

Available online 24 March 2005

Abstract

The first part of this paper gives a short tutorial survey of Internet traffic modeling, focusing on recent advances in Markov models showing pseudo-LRD (Long Range Dependence) characteristics that match those measured on the Internet. The interest in Markov models of Internet traffic, in spite of the impossibility to achieve true LRD or Self-Similarity, lies in the possibility of exploiting powerful analytical techniques to predict the network performance, which is the ultimate goal when adopting models to either study existing networks or design new ones.

Then, the paper describes a new MMPP (Markov Modulated Poisson Process) traffic model that accurately approximates the LRD characteristics of Internet traffic traces over the relevant time scales. The heart of the model is based on the notion of sessions and flows, trying to mimic the real hierarchical generation of packets in the Internet. The proposed model is simple and intuitive: its parameters have a physical meaning, and the model can be tuned with only a few input parameters. Results prove that the queuing behavior of the traffic generated by the MMPP model is coherent with the one produced by real traces collected at our institution edge router under several different traffic loads. Due to its characteristics, the proposed MMPP traffic model can be used as a simple and manageable tool for IP network dimensioning, design and planning; the paper provides examples of its application in both simulative and theoretical analysis.

© 2005 Elsevier B.V. All rights reserved.

Keywords: Internet traffic; Markovian models; MMPP

1. Introduction

The fact that packet flows arriving at Internet routers (both edge and backbone) cannot be accurately modeled by Poisson processes is widely accepted, and has been discussed in a vast literature [1–5].

One of the main characteristics of Internet traffic, probably the one with the most impact on planning and dimensioning, is the Long Range Dependence (LRD) of the distribution of several traffic parameters (packet inter-arrival time, amount of data transferred per time unit, etc.). LRD means that Internet traffic has some sort of *memory*; however, long-term correlation properties, heavy tail distributions, and all other characteristics of Internet traffic,

are meaningful only over a limited range of time scales. For instance, any correlation property on time scales smaller than the packet transmission time has no physical meaning. Similarly, heavy-tails of distributions describing file lengths become meaningless beyond the limitations imposed by storage media.

A number of traffic models have been derived by fitting real measured Internet traffic traces (we discuss some of them in Sections 2 and 3). While these models succeed in correctly representing the original trace, they seldom allow the generation of traffic with desired characteristics different from the original trace. However, a model of Internet traffic, in order to be effectively used for network dimensioning, must be simple, easy to understand, and, most important, must be controlled through a small number of parameters, whose influence on the generated traffic is predictable, at least from a qualitative point of view.

This paper is divided into two distinct parts. The first one (Sections 2 and 3) provides a short tutorial survey of recent Internet traffic models, focusing mainly on Markovian approaches, that are more related to the second part of the paper (Sections 4, 5 and 6) which is devoted to the proposal

[☆] This work was supported by the Italian Ministry for Education, University and Research through the TANGO (in Torino) and GRID.IT (in Trento) projects.

* Corresponding author. Tel.: +39 0115644032; fax: +39 0115644099.
E-mail address: ajmone@polito.it (M. Ajmone Marsan).

of a new MMPP-based traffic model. Section 7 finally concludes the paper.

The simple Markovian model of Internet traffic we propose in the second part of this paper, matches very well the characteristic of the Internet traffic observed at an edge router (the result of the aggregation of many individual packet flows). The model is based on *Markov Modulated Poisson Processes* (MMPPs), and aims at providing a description of the traffic generation process as close as possible to the typical behavior of real Internet applications. The model employs the notion of three entities: *sessions*, *flows* and *packets*; which act at different time scales, and mimic the real behavior behind the interaction between users, protocols, and the network.

The model has five parameters which are very simple to tune, so that two major tasks can be accomplished: first, fit the characteristics of a real trace, second, generate traffic with known statistical properties. Three of the parameters are mapped directly on average traffic characteristics, such as the average load and flow size; two parameters are used to shape the correlation properties of the traffic. This tunability feature, combined with the simplicity of the model, makes it a very effective synthetic generator of aggregate Internet traffic, that can be used in simulation and analytical models to predict the network behavior as the traffic characteristics change. Finally, the MMPP traffic model also allows the derivation of analytical solutions of its queuing behavior in cases that, despite their simplicity, are of practical interest. The analytical solutions are very efficient, and provide a useful alternative to simulations.

2. Modeling internet traffic

In the early 1990s, two seminal papers [1,2] showed that traffic traces captured on both LANs and WANs exhibit Long Range Dependence (LRD) properties, and self-similar characteristics at different time scales. Those discoveries spurred a significant research effort to understand data traffic in packet networks in general, and in the Internet in particular. In addition, the evidence of LRD and of self-similar properties in packet traffic drove many researchers to abandon the usual Markovian assumptions in favor of newer and more complex traffic models. A number of attempts were made to develop models for LRD data traffic. Here we briefly summarize some of the main approaches proposed in the literature.

Looking at packet traffic as a superposition of source–destination traffic flows, simple *ON/OFF models* (or *packet trains models*) were proposed as a first way to mimic LRD properties [3,4]. Indeed, if the *ON* (*OFF*, or both) periods are generated according to heavy-tailed distributions, and the number of multiplexed flows is large, then the resulting aggregate traffic exhibits asymptotic self-similar properties with LRD behavior, as proved in [4].

An $M/G/\infty$ queue with infinite variance service time exhibits LRD properties in the number of active servers [6]. Since a heavy-tailed distribution of file sizes was measured on storage devices [5,7,8], it can be mapped onto the service time of a file transfer.

Other recent studies [9,10] indicate instead that traffic properties are rooted in the TCP congestion control mechanism, which induces LRD properties in the aggregate traffic resulting from the superposition of independent sources. Other authors underlined that TCP induces correlation at packet level on a limited range of time scales [11].

The statistical analysis of real traffic traces, due to the significant amount of collected data and of research projects, gave new impulse to traffic modeling. Among the numerous generic LRD models proposed in the literature, *Fractional Brownian Motion* (FBM) received a lot of attention, since its Gaussian nature helps in the study of the queuing behavior [12,13]. However, this model presents a restrictive correlation structure, that fails to capture the short-term correlation of real traffic and its rich scaling behavior. Therefore, many research efforts were devoted to *Multifractal* models [14], whose attractiveness is due to their rich scale-invariance properties. Indeed, previous analytical works, such as [7,8,15–17] suggested Multifractal models as possibly being the best fit to measured data. ‘Cascades’, a multifractal subclass [18,19], are also extensions of self-similar models and capture traffic behavior at all meaningful time scales. While these models give good approximations of the LRD properties of Internet traffic, they are difficult to manage, due to their analytical complexity.

Wavelet decomposition has been widely used as a natural approach to study scale invariance, but only recently they were introduced in the field of data networks. There are many examples of measurement-based traffic models, which try to fit the LRD properties of real traffic [20,21]. These models are computationally very efficient, but they are complex and difficult to tune, due to the lack of a mapping between the traffic parameters and the model coefficients.

Chaotic map models [22,23] were proposed as a deterministic evolution of systems governed by a set of behavioral rules. The derived models are simple, but it is often difficult to understand the relationship between the model and real traffic parameters.

FARIMA models [24] are widely used in video trace modeling, and can be used to generate LRD sequences. These models are derived by filtering white Gaussian noise, and capture both the short and the long period correlations of traffic. However, the models are quite complex, and their structure makes it very hard to understand the relationship among the filter coefficients and the real traffic data.

The use of α -stable processes has been also proposed as a possible means to model Internet traffic [25] by fitting

the heavy-tailed distribution of the marginal of the bit-rate process.

Another approach to model Internet traffic involves the emulation of the real hierarchical nature of network dynamics; in [33], each of the model components was fitted to real objects, such as the distribution of both TCP flows and web pages size, and the arrival distribution of pages and flows. In this paper, we follow a similar approach, but instead of trying to fit all possible distributions to measurements, we use a much simpler Markovian definition.

In spite of the many proposed traffic models with LRD characteristics, very little work appeared in the field of network design and planning, or network performance analysis, based on LRD traffic models. This is mainly due to the difficulty in handling the complex mathematical structure of the stochastic processes on which those traffic models are based. Moreover, in [34] it was recently shown that the long-term correlation of traffic beyond a certain threshold does not influence the performance of a system, so that simple models where correlation is limited (such as MMPP models) can be successfully employed.

The results in [35,36] also provide support to the possibility of using Markovian traffic models in packet networks, showing that bandwidth sharing in packet networks is insensitive both to the flow size, and to the flow arrival process, under the quite commonly accepted assumption [2,3] that session arrivals are Poisson. We do not consider these two papers in Section 3 since they are not concerned with modeling the packet arrival process within the network, but with deriving insensitivity results for high level performance with respect to the arrival process itself.

All of these different approaches reach similar conclusions using different techniques. The objective is always to take into account as accurately as possible the real traffic behavior, in order to: (i) use more realistic tools for network planning, and (ii) relate causes and effects of network traffic phenomena.

3. Markovian models of internet traffic

Parallel to the effort of understanding the deep reasons for the LRD and self-similarity exhibited by Internet traffic, the research community started to investigate how the next generation of networks could be planned taking into account the traffic characteristics. Unfortunately, none of the mathematical models that present LRD, self-similarity, and scale invariance (some of them discussed in Section 2) allow an analytical solution when they are used as traffic generators feeding queueing systems, even the simplest single server queues. Even their use in simulations is often troublesome, since several properties of the models are meaningful only when asymptotic condition are considered, but such conditions are not met in simulations. This is fundamentally the reason that drives researchers to devise

Markovian models (MMPP, MAP, B-MAP, etc.) that try to match the characteristics of the measured traffic and yet are analytically tractable and relatively easy to understand.

3.1. Nearly completely decomposable Markov chains

Among the first attempts to use Markovian modeling, in [29–31] the authors propose the use of discrete time Markov chains (DTMC) to modulate the packet arrival process. The key of the modeling process is the use of nearly decomposable chains, that have transients behaviors that are local to the initial state.

A fully decomposable DTMC is non-ergodic and its transition probability matrix \mathbf{A}^* is composed of squared sub-matrices on the diagonal (sticking to the notation in [29])

$$\mathbf{A}^* = \begin{pmatrix} \mathbf{A}_1^* & 0 & 0 & \cdots & 0 \\ 0 & \mathbf{A}_2^* & 0 & \cdots & \vdots \\ \vdots & \ddots & \ddots & \ddots & \vdots \\ 0 & \cdots & \cdots & 0 & \mathbf{A}_N^* \end{pmatrix}$$

so that sub-parts of the Markov chain defined by \mathbf{A}_i^* and \mathbf{A}_j^* are unreachable.

A nearly completely decomposable DTMC is ergodic, but the chain tends to evolve locally, since the transition probability between different set of states are very low. The class of nearly completely decomposable DTMC proposed in the paper is defined with only three parameters: $a, r < 1$, and the number of states n in the DTMC. The DTMC is defined by the transition probability matrix

$$\mathbf{A} = \begin{pmatrix} 1 - 1/a - 1/a^2 - \cdots - 1/a^{n-1} & 1/a & 1/a^2 & \cdots & 1/a^{n-1} \\ & r & & & 1 - r & 0 & \cdots & 0 \\ & r^2 & & & 0 & 1 - r^2 & \ddots & 0 \\ & \vdots & & & \ddots & \ddots & \ddots & \vdots \\ & r^{n-1} & & & 0 & \cdots & 0 & 0 \end{pmatrix}$$

Depending on the value of n, a , and r , the traffic generated by the model displays *pseudo-LRD characteristics* (a term defined by the authors) over finite time scales.

The model is proved to emulate well both the correlation structure (Hurst parameter) and the queueing behavior of measured data.

This model is in some sense related to the one we propose later on in the paper, since the key idea behind both of them is obtaining a model that has fast transients on a local scale and evolves with a slower time constant between different groups of states, in other words a model that has some implicit form of memory. The difference lies in the structure of the model: our model is based on an infinite CTMC whose structure is hierarchically defined by the notions of sessions and flows, which are completely absent in the nearly completely decomposable chain model. In addition,

the parameters n , a and r in this model are not easily related to traffic characteristics.

3.2. MMPP models

In [32], the authors propose the use of a Batch Markov Arrival Process (B-MAP) generated by a non-ergodic CTMC with an absorbing state and N transient states. The process is initialized in a transient state and as soon as it reaches the absorbing state, it is re-initialized in a transient state, restarting the cycle. Packets are generated when the process reaches the absorbing state and their dimension (the batch) is determined as a reward depending on the last state i visited before absorption.

The re-initialization state j is dependent on the last state i visited before absorption, thus introducing memory and correlation in the generation process. Transitions between transient states do not correspond to packet generation, but allow the inter-arrival process to be described as an arbitrarily complex superposition of exponential distributions, mimicking again LRD characteristics. In order to determine the B-MAP coefficients, the authors employ a sophisticated (albeit efficient) technique named Expectation-Maximization (EM), which is a Maximum-Likelihood (ML) estimation technique that works also when the observed data is only a subset of the complete experiment that would allow standard ML estimation. The observable data in a traffic trace are only the packet size distribution and the inter-arrival time distribution, so that all transitions between transient states cannot be fitted directly and must be inferred with the EM algorithm.

The authors fit a 1,500,000 packet trace measured on a dial-up multiplexing point with a three-state B-MAP allowing for three different packet sizes. The results show a better agreement with the generated traffic with respect to simple Poisson and MMPP generators (although the structure of the MMPP is not defined). However, the queueing behavior of the generated traffic tends to diverge from the measured one as soon as the queue traffic intensity ρ exceeds 0.5.

This model does not allow ‘what-if’ studies, since the B-MAP parameters are not directly coupled to traffic characteristics and a new fit of the B-MAP must be performed to match the characteristics of every data set.

The MMPP model proposed in [26] aims at generating traffic with multifractal scaling behavior. Thanks to the special structure of the continuous time Markov chain modulating the process, which is symmetric and n -dimensional, the authors impose a correspondence between the parameters of the wavelet transform at different levels of aggregation and the traffic generated by the MMPP process at different time scales. The MMPP is composed of 2^n states and it is described by $n+2$ parameters. Moreover, the authors propose an heuristic approach to derive the values of the MMPP parameters such that the generated synthetic traffic fits a

measured data set. The well-known Bellcore traces are fitted with the proposed model for $n=5$, and a number of tests are performed to evaluate the accuracy of the fitting. Moreover, comparisons are derived also for the queueing behavior and prove that the model is accurate, especially for high values of the load.

The MMPP models in [27,28] are shown to provide good matches of LRD properties under large time scales. In particular, the authors of [27] suggest the superposition of two-state Markovian sources as a very versatile tool for modeling variable packet traffic with LRD. A fitting procedure is proposed to match the covariance function of the Markovian model to that of second order self-similar processes over several time scales.

In [28], the authors propose an MMPP model and a fitting procedure similar to the one used in [27], but extend the model to include a variable number of states. A novel feature of this approach is that the number of time scales is part of the fitting procedure, and therefore the approximation interval can be made accurate or coarse. The MMPP is constructed as a superposition of L 2-MMPPs and one M-MMPP. The 2-MMPPs are designed to match the auto-covariance and the M-MMPP to match the marginal distribution. Each 2-MMPP models a specific time-scale of the data. The procedure starts by approximating the auto-covariance by a weighted sum of exponential functions that model the auto-covariance of the 2-MMPPs. The auto-covariance tail can be adjusted to capture the long-range dependence characteristics of the traffic, up to the time-scales of interest. The procedure then fits the M-MMPP parameters in order to match the marginal distribution, within the constraints imposed by the auto-covariance matching. The number of states is also determined as part of this step. The final MMPP with $M2^L$ states is obtained by superposing the L 2-MMPPs and the M-MMPP. Very good results are obtained, both in terms of queueing behavior and number of states, for examined the traces, which include the Bellcore traces.

In both the approaches above, the individual parameters obtained in the models have a real physical interpretation. In the rest of the paper we describe a new, structured MMPP model which instead has a structure that stems from the layered architecture of the Internet. This allows an easy mapping of the model parameters to the physical parameters, and therefore permits predictions of the model output when some parameters change.

We start with traffic measurements and analysis performed on the access router of Politecnico di Torino for over 2 years, also precisely defining concepts, notation and limits of Markovian models (e.g. only a *local* Hurst parameter can be defined and LRD can be defined only on limited time scales). Then, we move on to define the model structure, its performance and its analytical solution. Preliminary results on its queueing behavior and characteristics were presented in [37].

4. Traffic measurement and analysis

In order to collect traffic traces, we observed the data flow on the Internet access link¹ of our institution, i.e. we focus on the data flow between the edge router of Politecnico di Torino and the access router of GARR/B-TEN [38], the Italian and European Research network. For traces collection and processing we used `tcp-dump` [39] and `Tstat` [40,41]. `Tstat` is a new software tool developed at Politecnico di Torino, which analyzes traces, and derives traffic characteristics at both the IP and TCP levels. For the analysis at the TCP level, `Tstat` rebuilds each TCP connection status by looking at the TCP header in the forward and backward packet streams. In order to do so, `Tstat` requires as input a trace collected on an edge node, such that both data segments on the forward stream and ACKs on the backward stream can be analyzed. Additional information about `Tstat` and statistical analysis performed on collected traces can be found in [40,41].

The Politecnico LAN comprises approximately 7000 hosts; most of them act as clients, but several servers are also regularly accessed from outside hosts. Data were collected on files storing 6 or 3 h long traces (to avoid exceeding the File System limitation on the file size), for a total of more than 100 GB of compressed data. Traces were collected during different periods, which correspond to different phases of the network topology evolution. In this paper, we present results considering two periods which are characterized by a significant upgrade in network capacity:

- April 2000, from 4/11/2000 to 4/14/2000: the bandwidth of the access link was 4 Mbit/s, and the link between the GARR network and the corresponding US peering was 45 Mbit/s;
- February 2001, from 2/1/2001 to 2/19/2001: the bandwidth of the access link was 16 Mbit/s, and of the link between the GARR network and the corresponding US peering was 622 Mbit/s.

The campus access link was a bottleneck during April 2000, while it was not during February 2001. The same consideration applies to the GARR-US peering capacity, which plays a key role, since most of the traffic comes from US research sites. Among all the traces we collected, we report here results from four traces, which we consider representative of different network scenarios. Table 1 summarizes the key parameters of the selected traces; the last two columns report the number of samples in a trace, i.e. the number of IP packets and of TCP flows. Since our campus network can be mainly considered as a ‘client’ network, i.e. hosts in the network are mainly destinations of information, in the remaining of this paper we will present

results considering incoming streams of data only, both at the TCP flow level and at the IP packet level.

4.1. Definitions

Several different definitions of LRD exist (which in general are not equivalent [42]). We recall in this section the definition we use in this paper, which is the one proposed in [43].

4.1.1. Definition (long range dependence)

Let $\{X_k\}_{k \in \mathbb{Z}}$ be a wide sense stationary random sequence, with mean μ , auto-covariance function $\gamma(n)$, and spectral density $f(\nu)$ $\nu \in [-\pi, \pi]$

$$\mathbb{E}[X_k] = \mu \quad (1)$$

$$\mathbb{E}[(X_k - \mu)(X_{k+n} - \mu)] = \gamma(n), \quad n \in \mathbb{Z} \quad (2)$$

$$f(\nu) = \frac{1}{2\pi} \sum_{n=-\infty}^{+\infty} e^{-in\nu} \gamma(n) \quad (3)$$

$$\gamma(n) = \int_{-\pi}^{\pi} f(\nu) e^{-in\nu} d\nu \quad (4)$$

$\{X_k\}_{k \in \mathbb{Z}}$ is *Long-Range Dependent* if

$$\gamma(n) \sim an^{\alpha-1}, \quad n \rightarrow \infty, \quad \alpha \in (0, 1) \quad (5)$$

or if

$$f(\nu) \sim c|\nu|^{-\alpha}, \quad \nu \rightarrow 0, \quad \alpha \in (0, 1) \quad (6)$$

where $f(x) \sim g(x)$ as $x \rightarrow x_0$ means $\lim_{x \rightarrow x_0} f(x)/g(x) = 1$. Eqs. (5) and (6) are equivalent if $\gamma(n)$ is monotone. In the following we use the definition in (6), that is based on two parameters: (α, c) . The parameter $\alpha \in [0, 1]$ is the dimensionless scaling exponent, and describes the ‘intensity’ of LRD; for a non-LRD stationary process, $\alpha = 0$ at large scales. The parameter $c \in \mathbb{R}^+$ has the same dimension of the variance of the process and describes the quantitative aspect of LRD often referred to as the *LRD size*. LRD implies that the sum of correlations over all lags is infinite; however, individually, their sizes at large lags are proportional to c , and can be arbitrarily small. LRD is usually associated with *self-similar processes with stationary increments* (H-sssi) defined as follows.

4.1.2. Definition (self-similarity)

Let $\{Y(t), t \in \mathbb{R}\}$ be a random process; $\{Y(t)\}$ is said to be *H-self-similar* (H-ss) if

$$\{Y(t), t \in \mathbb{R}\} \stackrel{d}{=} \{r^{-H} Y(rt), t \in \mathbb{R}\}, \quad \forall r \in \mathbb{R}^+, \quad H > 0$$

The above equality holds for any finite dimensional distribution. If $Y(t)$ has stationary increments $\{X_k\}_{k \in \mathbb{Z}}$, $X_k = Y(k-h) - Y(k)$ is LRD with

$$\alpha = 2H - 1 \quad \text{if } H \in (0.5, 1) \quad (7)$$

¹ The data-link level exploits an AAL-5 ATM virtual circuit over an OC-3 link.

Table 1
Summary of the analyzed traces

Name	Date	Start time	Stop time	No. of IP packets (millions)	No. of TCP flows (thousands)
Peak'01	2 Feb'01	10:52	13:52	11.0	540
Night'01	2 Feb'01	04:52	07:52	0.43	30
Peak'00	13 Apr'00	08:10	14:10	12.0	564
Night'00	13 Apr'00	02:10	08:10	0.92	79

The parameter H is known as the *Hurst parameter*. When considering the process of the increments of a self-similar process with stationary increments, relationship (7) holds; hence, it is common practice (though not completely proper) to use the parameter H when discussing LRD, and we stick to this practice. Clearly, a non-LRD process has $H=0.5$, while Hurst parameters larger than 0.6–0.8 are normally assumed as an indication of strong LRD.

4.2. Trace analysis

In order to estimate the LRD properties of the stochastic process of interest, we use the wavelet-based approach developed in [43,44] and the tools presented there, that are usually referred to as the *AV estimator*. We also employ the code made available from the authors in [45]. Other approaches can be pursued to analyze traffic traces, but the wavelet framework has emerged as one of the best estimators, as it offers a very versatile environment, as well as fast and efficient algorithms.

Since traffic traces are finite, and their asymptotic behavior cannot be derived, we always limit the analysis between two scales (j_{inf} , j_{sup}). In order to evaluate LRD parameters, we use the Log-Scale Diagram, which is essentially a log–log plot of the mean square value estimates of the wavelet coefficients x_n^j versus the scale j . Since 2^{-j} has the dimension of a frequency, j is generally called *octave*. Through the Log-Scale Diagram, it is possible to identify the presence of LRD and determine the cutoff scales (j_{inf} , j_{sup}) at which LRD ‘begins’ and ‘ends.’ Within these scales, an LRD process Log-Scale Diagram is linear with coefficient α . Indeed, for all processes in our measures, j_{sup} is limited by the trace length, and j_{inf} corresponds to a scale of a few hundred milliseconds.

Table 2
Flow level analysis of traces

Trace	Peak'01			Night'01			Peak'00			Night'00		
	\hat{H}_f	\hat{c}_f	$1/\hat{\Lambda}_f$	\hat{H}_f	\hat{c}_f	$1/\hat{\Lambda}_f$	\hat{H}_f	\hat{c}_f	$1/\hat{\Lambda}_f$	\hat{H}_f	\hat{c}_f	$1/\hat{\Lambda}_f$
I (ms)	0.74	82.4	20.01	0.86	8491.0	358.9	0.76	275.1	39.6	0.74	2414.0	271.6
$N_{1\text{ s}}$	0.76	59.4	49.9	0.76	1.66	2.79	0.75	28.4	25.9	0.78	1.54	3.68
$N_{100\text{ ms}}$	0.75	2.01	4.99	0.73	0.07	0.28	0.74	0.79	2.53	0.76	0.06	0.37
$N_{10\text{ ms}}$	0.74	0.07	0.49	0.80	0.001	0.028	0.75	0.015	0.25	0.78	0.001	0.04

Among all the possible metrics that can be derived from the traces, we selected as most representative of the traffic characteristics:

- the (packet and flow) inter-arrival time processes $I(k)$
- the (packet and flow) counting processes $N_T(n)$, obtained by counting the number of arrivals in a time interval $[nT, (n+1)T)$; we use three values of T : 1, 0.1, 0.01 s

Combining the three tools (*Tstat*, *tcpdump*, and *AV*) we analyzed the metrics defined above at both the TCP flow and IP packet levels.

4.3. Flow and packet level analysis

Given a trace and a process under analysis, the *AV estimator* produces estimates of three main parameters: the Hurst parameter, the c factor and the mean value. Estimates are denoted by \hat{H}_f , \hat{c}_f , and $1/\hat{\Lambda}_f$ when traces are analyzed at the flow level; and by \hat{H}_p , \hat{c}_p , and $1/\hat{\Lambda}_p$ for the packet level analysis. Results for the four traces we consider are reported in Tables 2 and 3 for the flow level analysis and for the packet level analysis, respectively. In the tables, I denotes the inter-arrival time process, N_T the counting process in time intervals whose duration is equal to T .

Apart from the obvious consideration that during peak hours arrival rates are much higher than during nights, a few observations are in order. First of all, notice that all processes show similar values of the Hurst parameter, ranging from 0.71 to 0.88. Indeed, \hat{H}_f is almost independent from the considered trace or process; while \hat{H}_p is slightly higher during peak hours (around 0.88) than during nights. These results hint to the fact that LRD in packet networks is probably not due to high load. Moreover, since the network characteristics of

Table 3
Packet level analysis of traces

Trace	Peak'01			Night'01			Peak'00			Night'00		
	\hat{H}_p	\hat{c}_p	$1/\hat{\Lambda}_p$	\hat{H}_p	\hat{c}_p	$1/\hat{\Lambda}_p$	\hat{H}_p	\hat{c}_p	$1/\hat{\Lambda}_p$	\hat{H}_p	\hat{c}_p	$1/\hat{\Lambda}_p$
I (ms)	0.87	0.01	0.89	0.71	5×10^{-4}	0.025	0.84	0.17	2.25	0.84	40.54	15.74
N_{1s}	0.88	5232.0	1113.0	0.73	457.8	40.06	0.86	504.19	444.75	00.83	133.93	63.51
N_{100ms}	0.88	91.4	111.3	0.72	16.6	4.00	0.87	14.50	44.49	0.83	3.61	6.35
N_{10ms}	0.88	1.50	11.1	0.76	0.30	0.4	0.88	0.23	4.45	0.87	0.04	0.63

the four selected traces are very different (different link speeds, different loads, different patterns between peak and night hours), this can be taken as a strong indication that LRD is an intrinsic characteristic of the Internet traffic and is not induced by network conditions; this is coherent with the ‘Pareto effect’ due to file size distributions, assumed as a good explanation of LRD at packet level. A second consideration concerns c , whose value is extremely variable, and clearly connected to the absolute magnitude of the analyzed process (indeed, it is connected to the mean square value of the process itself). The last consideration is that the characteristics of the measured traces do not change significantly from 2000 to 2001; thus, in the sequel we will only present results for these latter traces, that are more recent.

For the model development, besides the estimates mentioned above, we also derived from the traces:

\hat{N}_p the average number of packets per flow,
 $\hat{\lambda}_p$ the packet generation rate of active flows (obtained as the ratio between \hat{N}_p and the average flow duration).

5. A new MMPP traffic model

Today, Internet traffic is mainly generated by data transfers that use the TCP protocol at the transport layer. We derive our model by keeping in mind that, in layered architectures, the human actions on a terminal interface cause a sequence of events and behaviors of the protocols at the various layers of the protocol stack. For example, a ‘click’ on a web link causes the generation of a request at the application level (i.e. an HTTP request), which is translated into many transport level connections (TCP flows); each connection generates a sequence of data segments that are transported by the network through IP packets.

According to this view, we, as other authors, propose a model whose behavior is driven by entities which act at three different time scales. At the application level, *sessions* correspond to bunches of information transfers. Sessions generate *flows* which correspond to TCP connections. Each flow generates a sequence of *packets* injected into the network. Fig. 1 sketches a realization of the model; three

sessions arrive, each one generates a given number of flows, and each flow, generates a given number of packets, that will be multiplexed on links along the source–destination paths.

In order to derive a model which emulates the behavior of a given real trace, we need to map the three model entities (sessions, flows and packets) into entities which can be observed in real traces. Packets and flows can be easily identified on the real trace; in particular, a flow is a single TCP connection, which starts with the three-way-handshake procedure and ends with the closing procedure.² On the contrary, it is more difficult to provide a specific and unique definition of a session. Indeed, many different definitions of a session could be proposed on the basis of traces. All the web pages downloaded by a user from the same web server in a limited period of time can form a session; an ftp connection from a user that requests many files from a server can form a session; all the e-mail messages generated by a user that replies to all the previously downloaded e-mails, or even the user activating its connection to the Internet (for example by switching on its computer), are all possible definitions of a session. Thus, we have the following problem. On the one hand, sessions are difficult to define, and to recognize in real traces. On the other hand, we need a notion of session in order to account for correlation over long time scales, which a model based on flows and packets alone cannot catch. We resort to define a session as a generic set of correlated flows that are submitted to a network interface; then, we use the flow and packet levels of the model to fit the metrics which are easy to measure on real traces, and we specify the model session level so that the LRD of the real traces is accurately approximated.

We assume the following concerning the behavior of sessions, flows and packets:

- Sessions are generated according to a Poisson process with rate λ_s ; each session starts by generating a new flow and ends when it generates the last flow belonging to the session.
- The number of flows generated by a session is a geometrically distributed random variable with mean value equal to N_f .

² In case no packets are observed for more than 30 min, the flow is declared closed as well.

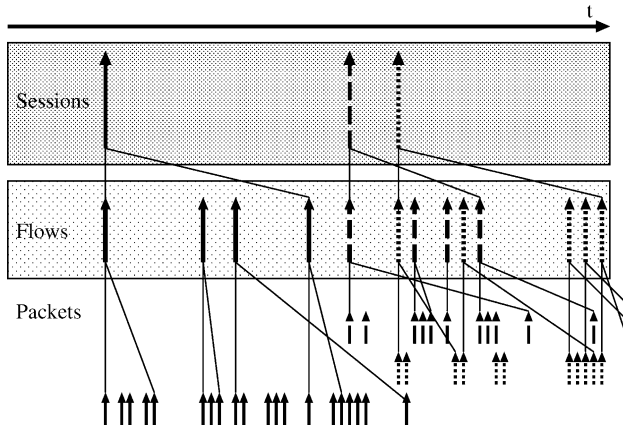

Fig. 1. Sessions, flows, and packets as seen by the model.

- Flows belonging to the same session are generated according to a Poisson process with rate λ_f ; each flow starts by generating a packet and ends after generating the last packet of the flow.
- The number of packets generated by a flow is a geometrically distributed random variable with mean value equal to N_p .
- Packets belonging to the same flow are generated according to a Poisson process with rate λ_p .

Due to the above assumptions, both the packet arrival process and the flow arrival process are MMPP, whose memory is given by two variables: the number of active flows, which accounts for short-term correlation, and the number of active sessions, which determines correlation over long time lags. Observe that the model analysis can also use the same formalism used in [46].

5.1. Setting the model parameters

The MMPP model above is completely described by five parameters:

- λ_s the arrival rate of new sessions,
- λ_f the flow arrival rate per active session,
- λ_p the packet arrival rate per active flow,
- N_f the average number of flows per session,
- N_p the average number of packets per flow.

The parameters N_p and λ_p are set to match the packet and flow behaviors of a given trace; i.e. they are set equal to the measured average number of packets per flow and average packet arrival rate per flow. For what concerns N_f and λ_s , since they are related to the session behavior, they are harder to measure from traces. Thus, we set N_f and λ_s to match the Hurst parameters \hat{H}_f and \hat{H}_p ; this is done by means of an iterative procedure described below. Finally, given the session behavior, the parameter λ_f (the flow arrival rate per session) is simply set to match the average flow arrival rate observed from the traces. The fitting procedure is

- (1) From the traffic traces estimate $\hat{H}_p, \hat{H}_f, \hat{\lambda}_p, \hat{\lambda}_f, \hat{N}_p$
- (2) Set $N_p = \hat{N}_p$ and $\lambda_p = \hat{\lambda}_p$
- (3) Set the initial values $N_f = 1$ and $C = 1$ (C is defined as $C = \lambda_s / \lambda_f$)
- (4) Compute $\lambda_s = \frac{\hat{\lambda}_f}{N_f}$ and $\lambda_f = \frac{\lambda_s}{C}$
- (5) Generate a synthetic sequence with the same number of samples as the real trace
- (6) Estimate the Hurst parameter at both packet and flow level of the synthetic trace and compare them with \hat{H}_p, \hat{H}_f
- (7) If the fitting is good, the procedure ends else assign new values to N_f and C and go to step (4)

Fig. 2. Fitting procedure to derive the MMPP model parameters from a measured trace.

summarized in Fig. 2 (notice that, for the sake of convenience, in the fitting procedure we normalize the session arrival rate λ_s to the flow arrival rate per session λ_f , and denote the normalized arrival rate by C).

The selection of N_f and C by means of the fitting procedure at steps 4–7 can be performed according to different definitions of accuracy of the fit and to different criteria for the assignment of new values to the parameters. The detailed procedure which we followed is reported in Fig. 3.

The criteria to assign new values to N_f and C were chosen after having studied the sensitivity of the Hurst parameters H_f and H_p to changes of N_f and C by means of the graphs shown in Fig. 4. The Hurst parameter at both the flow and packet levels increases as N_f increases, consistently with the intuition that a larger value of N_f introduces a higher degree of memory in the system. Moreover, at the packet level, there is a higher degree of memory and correlation since packets are generated by flows which are generated by sessions. Let us now focus on C . The larger C is, the more bursty the generation of flows per session is. The influence of C on the Hurst parameter is quite complex. At the flow level, a higher degree of burstiness tends to induce a larger value of the Hurst parameter, while the opposite is true at the packet level.

The fitting procedure requires only a few iterations (approximately 10 in our tests). In order to verify that the synthetic traffic accurately emulates the real traces, we

```

C = 1; N_f = 1;
eps_f = eps_p = 0.05; fit = 0;
while !(fit){
    generate a synthetic sequence and estimate H_f, H_p;
    fit = (|H_f - \hat{H}_f| < eps_f) && (|H_p - \hat{H}_p| < eps_p);
    if (H_f < \hat{H}_f) then N_f = N_f + 5;
    else if (H_f > \hat{H}_f) then N_f = N_f - 1;
    if (H_p > \hat{H}_p) then C = 3 * C;
    else if (H_p < \hat{H}_p) then C = C/2;
}

```

Fig. 3. Selection of new parameters in the iteration.

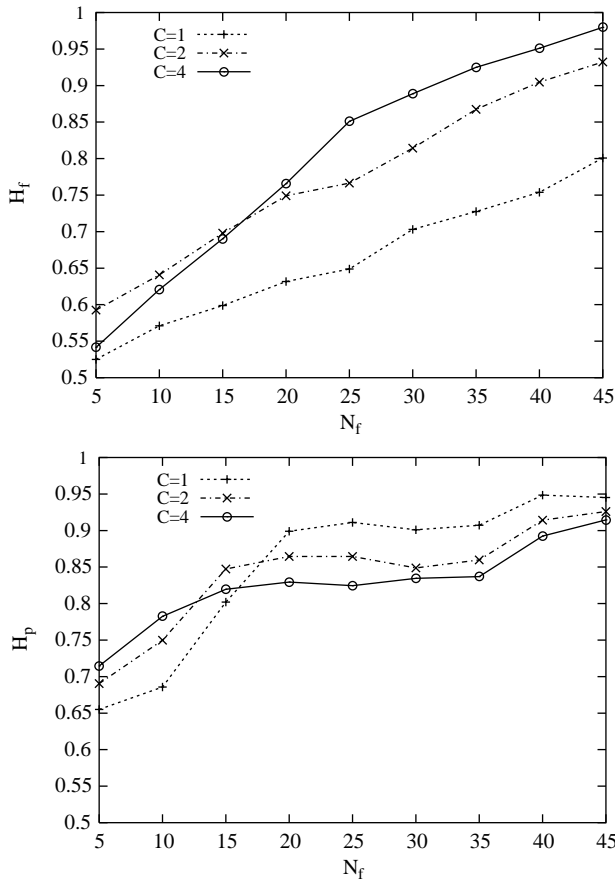

Fig. 4. Impact of N_f on the Hurst parameters of the flow arrival process, for different values of the normalized session arrival rate $C = \lambda_s/\lambda_f$.

report in Table 4 the characteristics of the synthetic traces measured by the AV tool when the model parameters are fitted to the 2001 traces; the values must be compared with those of Tables 2 and 3. Observe that, thanks to the fitting procedure, the Hurst parameters are well matched, while the values for the c parameters are less accurate, though the qualitative behavior is the same.

5.2. The modulating Markov chain

The Continuous-Time Markov Chain (CTMC) which modulates the packet and flow arrival processes is defined by the state variable $\bar{s} = (n_f, n_s)$, where n_f and n_s denote the number of active flows and the number of active sessions,

respectively. A state-transition diagram of the CTMC model of the modulating process is reported in Fig. 5.

The transition from state (n_f, n_s) to state $(n_f - 1, n_s)$ corresponds to the termination of a flow; its rate is $n_f \mu_f$, where $\mu_f = \lambda_p / (N_p - 1)$. The generation of a new flow makes the chain move from state (n_f, n_s) to state $(n_f + 1, n_s)$ with rate $\beta n_s \lambda_f$ if the flow is not the last one of the session, and to state $(n_f + 1, n_s - 1)$ with rate $(1 - \beta) n_s \lambda_f$ if the flow is the last one. The probability β that a generated flow is not the last one of a session is given by $\beta = 1 - 1/N_f$. In state (n_f, n_s) a session starts with rate λ_s and generates a new flow. If the session is composed of one flow only, the chain moves from (n_f, n_s) to $(n_f + 1, n_s)$ with rate $(1 - \beta) \lambda_s$; otherwise, the chain moves from (n_f, n_s) to $(n_f + 1, n_s + 1)$ with rate $\beta \lambda_s$.

The infinitesimal generator of the CTMC is infinite due to the unbounded values that n_s and n_f can take. Thus, in order to analyze the property of the MMPP or to evaluate the performance of a queue fed by the synthetic traffic generated by the MMPP we have two alternatives: (i) we resort to simulation, (ii) we truncate the CTMC so that the infinitesimal generator matrix becomes finite. In what follows we consider both cases. The criterion used for truncating the CTMC is described in Section 5.3. For the moment, assume that the CTMC has been truncated so that the number of active flows varies in the range $[f_m, f_M]$ and the number of active sessions varies in $[s_m, s_M]$.

We denote by $\{J(t), t \in \mathbb{R}^+\}$ the finite CTMC obtained by truncating the MMPP according to the above ranges. The state space is given by $S = \{(n_f, n_s) \in \mathbb{N}^2 | f_m \leq n_f \leq f_M, s_m \leq n_s \leq s_M\}$. The infinitesimal generator $Q \in \mathbb{R}^{n \times n}$ with $n = (f_M - f_m + 1) \times (s_M - s_m + 1)$ is given by

$$Q = \begin{pmatrix} Q_{f_m} & Q^+ & 0 & \dots & \dots & 0 \\ (f_m + 1)Q^- & Q_{f_m+1} & Q^+ & \ddots & \dots & \vdots \\ 0 & (f_m + 2)Q^- & \ddots & \ddots & \ddots & \vdots \\ \vdots & \ddots & \ddots & \ddots & \ddots & 0 \\ \vdots & \dots & \ddots & (f_M - 1)Q^- & Q_{f_M-1} & Q^+ \\ 0 & \dots & \dots & 0 & f_M Q^- & Q_{f_M} \end{pmatrix},$$

$$Q^- = \mu_f I_s; Q^+ = (1 - \beta) \lambda_f N_s^- + \beta \lambda_f N_s + (1 - \beta) \lambda_s I_s + \beta \lambda_s I_s^+$$

Table 4 Model: flow and packet level results fitting the '01 traces

Trace	Peak'01			Night'01			Peak'01			Night'01		
	H_f	c_f	$1/\Lambda_f$	H_p	c_p	$1/\Lambda_p$	H_p	c_p	$1/\Lambda_p$	H_p	c_p	$1/\Lambda_p$
I (ms)	0.74	19.2	20.1	0.84	7799.0	356.8	0.84	0.038	0.90	0.82	0.0001	0.025
N_{1s}	0.71	76.7	49.8	0.82	0.51	2.81	0.87	5943.0	1113.0	0.87	35.2	40.06
N_{100ms}	0.71	2.27	4.98	0.83	0.0076	0.28	0.82	178.2	111.4	0.79	2.05	4.01
N_{10ms}	0.78	0.013	0.50	0.79	0.0001	0.03	0.84	3.13	11.14	0.86	0.005	0.41

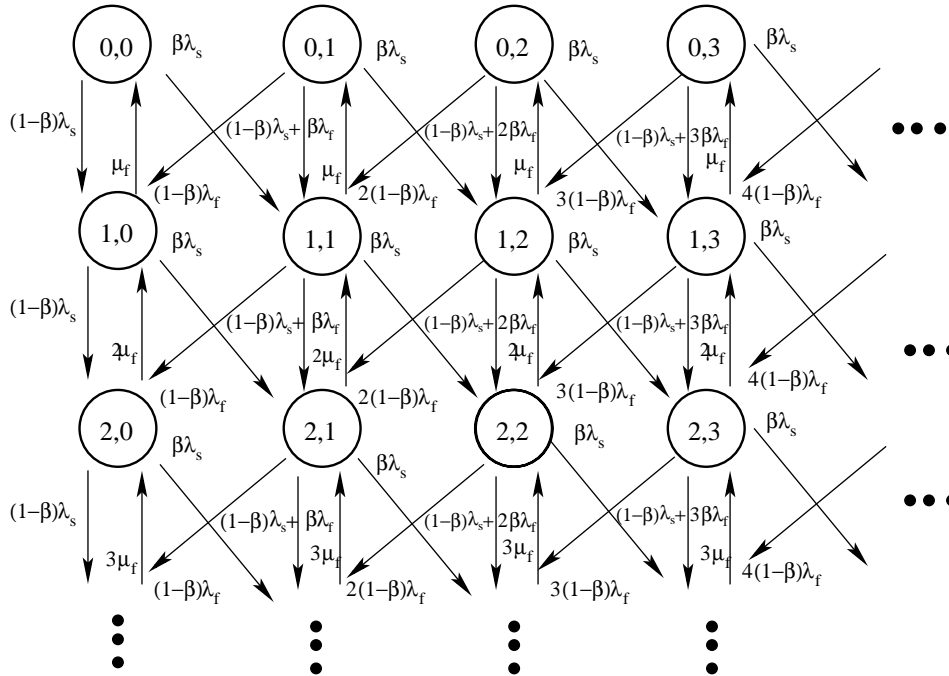

Fig. 5. State-transition diagram of the Continuous-Time Markov Chain that modulates arrivals.

$$I_s^+ = \begin{pmatrix} 0 & 1 & \dots & 0 \\ \vdots & 0 & 1 & \vdots \\ \vdots & \ddots & \ddots & 1 \\ 0 & \dots & \dots & 0 \end{pmatrix}; \quad N_s^- = \begin{pmatrix} 0 & 0 & \dots & 0 \\ s_m + 1 & 0 & \dots & \vdots \\ \vdots & \ddots & \ddots & 0 \\ 0 & \dots & s_M & 0 \end{pmatrix}$$

$I_s, I_s^+, N_s, N_s^- \in \mathbb{R}^{(s_M-s_m+1) \times (s_M-s_m+1)}$, I_s is the identity matrix. $I_s^- = I_s^{+T} N_s = \text{diags}\{s_m, s_m + 1, \dots, s_M\}$,³ $Q_i = \text{diags}\{-(s_m\beta\lambda_f + \lambda_s + i\mu_f), -[(s_m + 1)\lambda_f + \lambda_s + i\mu_f], \dots, -[(s_M - 1)\lambda_f + \lambda_s + i\mu_f], -[s_M\lambda_f + (1 - \beta)\lambda_s + i\mu_f]\}$, for $f_m < i < f_M$ $Q_{f_m} = \text{diags}\{-(s_m\beta\lambda_f + \lambda_s), -[(s_m + 1)\lambda_f + \lambda_s], \dots, -[(s_M - 1)\lambda_f + \lambda_s], -(s_M\lambda_f + \lambda_s)\}$ $Q_{f_M} = \text{diags}\{-f_M\mu_f, -f_M\mu_f, \dots, -f_M\mu_f\}$.

Q is a homogeneous irreducible infinitesimal generator if $\beta \neq 0, 1$. The steady-state probability vector π is given by

$$\pi Q = 0, \quad \pi e = 1$$

where $e = (1, 1, \dots, 1)$.

The rate matrix is $\Lambda \in \mathbb{R}^{n \times n}$, with $\Lambda = \lambda_p \text{diags}\{f_m I_s, (f_m + 1)I_s, (f_m + 2)I_s, \dots, f_M I_s\}$.

5.3. Truncating the modulating CTMC

Truncating the modulating CTMC, we have to trade-off between the opposite needs of reducing the dimension of the CTMC as much as possible in order to make the solution efficient and fast, and keeping the CTMC dimension large enough so that the truncated chain

accurately approximates the original infinite one. In order to find a proper truncation criterion, we first discuss the marginal distributions of n_s and n_f .

Let us focus on the number of active sessions, n_s . Sessions are generated according to a Poisson process with rate λ_s . The lifetime of a session, i.e. the time a session spends in the system, is given by the sum of the inter-arrival times of the flows generated by the session. Inter-arrival times between flows of a session are i.i.d. negative exponential random variables X_i with rate λ_f . The lifetime Y of a session is thus given by the sum of a geometric number of i.i.d. exponential random variables. It can be easily shown that Y is negative exponential with mean value $E[Y] = E[X]\beta/(1 - \beta) = \beta/[\lambda_f(1 - \beta)]$. Since sessions are independent from each other, the evolution of the number of sessions in the system can be modeled by an M/M/ ∞ queue, whose arrival rate is λ_s and whose mean service time is $E[Y]$. It follows that the distribution of n_s is Poisson with parameter $\delta = \lambda_s E[Y] = \lambda_s \beta / [\lambda_f (1 - \beta)]$.

We now consider the number of active flows, n_f . In order to model the flow arrival process, we number flows according to the order in which they are generated by the session they belong to: A flow of type i is the i th flow generated by a session. We model the flow arrival process by the infinite queuing network reported in Fig. 6a, where arrivals at queue i represent the arrivals of type i flows. The service time of a customer in queue i represents the inter-arrival time between the i th flow and the $(i + 1)$ th flow of a session and is distributed according to a negative exponential distribution with rate λ_f . Since type 1 flows are generated at the arrival of sessions, type 1 flows arrive at queue 1 according to a Poisson process with rate λ_s . A customer

³ The operator $\text{diags}\{x_1, x_2, \dots, x_n\}$ defines a diagonal matrix in $\mathbb{R}^{n \times n}$ whose elements along the diagonal are given by x_1, x_2, \dots, x_n .

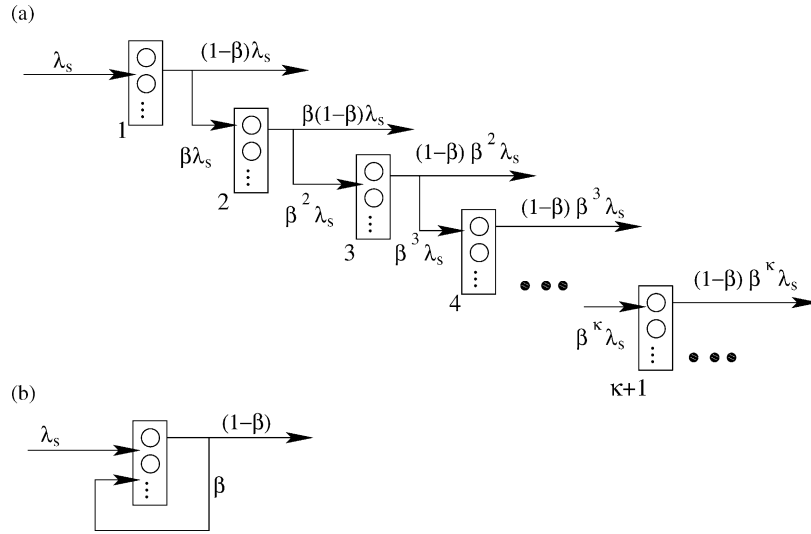

Fig. 6. Queuing network model of flow arrivals: (a) as an infinite number of queues; (b) as a single queue with feedback.

leaving queue 1 enters queue 2 with probability $(1 - \beta)$, which is the probability that the flow was not the last one of the session. Since the departure process from an infinite queue with Poisson arrivals is Poisson too, the arrival process at queue 2 is Poisson with rate $(1 - \beta)\lambda_s$. Thus, the arrival process at queue i is Poisson with rate $\beta^{i-1}\lambda_s$. This queuing network is equivalent to the queue with feedback shown in Fig. 6b. Notice that, as it is well known, despite the arrival processes at all queues in Fig. 6a are Poisson, the infinite sum of the arrival processes which is the process entering the queue with feedback in Fig. 6b is not Poisson.

Since the lifetime of flows in the system is negative exponential distributed with rate μ_f , the behavior of flows can be described by a set of infinite M/M/ ∞ queues, where the arrival rate at queue i is equal to $(1 - \beta)^{i-1}\lambda_s$ and the average service time is given by $1/\mu_f$, or equivalently by a queue with feedback as the one in Fig. 6b with μ_f instead of λ_f . It results that the distribution of n_f , the number of flows in the system, is Poisson distributed with rate $\lambda_s/(\beta\mu_f)$. Given that the marginal distributions of n_s and n_f is Poisson distributed, we can truncate the infinitesimal generator choosing (s_m, s_M) and (f_m, f_M) such that

$$\sum_{k \in \{s_m, \dots, s_M\}} p_{n_s}(k) = 0.9 \tag{8}$$

$$\sum_{k \in \{f_m, \dots, f_M\}} p_{n_f}(k) = 0.9 \tag{9}$$

where $p_{n_s}(k)$ and $p_{n_f}(k)$ are the probability density functions of n_s and n_f . We also tried values larger than 0.9 when truncating the marginal distribution but no major differences could be observed.

5.4. The buffer model (MMPP/M/1/m Queue)

For network planning and dimensioning, we are typically interested in the performance of a queue which represents

the bottleneck of a network. Besides the advantages of being simple to implement and efficient, a synthetic Markovian source as the one we propose has the additional advantage of allowing a Markovian model of a queue.

In general, the buffer model can be described by a MMPP/GI/1/m queue, where the service time represents the transmission time of a packet, and can be easily derived from the capacity of the link and the distribution of the packet length. The general service time distribution can be approximated by a phase type distribution. However, for simplicity, we consider the case of exponentially distributed service time; we validate the exponential assumption in Section 6 and we discuss the extension to phase type service times at the end of this section. By adopting an exponential service time distribution, we obtain an MMPP/M/1/m queuing system. The stochastic process which describes the dynamics of the system is a vector process $\{Z(t), t \in \mathbb{R}^+\}$, $Z(t) = \{R(t), J(t)\}$, where $R(t)$ denotes the number of packets in the queue, $J(t) = (n_f(t), n_s(t))$ denotes the phase of the modulating chain and it is a vector Markov process too.

The state space of the considered Markov process is

$$S = \{z = (r, n_f, n_s) \in \mathbb{N}^3 \mid 0 \leq r \leq m, f_m \leq n_f \leq f_M, s_m \leq n_s \leq s_M\}.$$

The infinitesimal generator of such a CTMC is A

$$A = \begin{pmatrix} A_{00} & A_0 & 0 & \cdots & \cdots & 0 \\ A_{10} & A_1 & A_0 & \ddots & \cdots & \vdots \\ 0 & A_2 & \ddots & \ddots & \ddots & \vdots \\ \vdots & \ddots & \ddots & \ddots & \ddots & 0 \\ \vdots & \cdots & \ddots & A_2 & A_1 & A_0 \\ 0 & \cdots & \cdots & 0 & A_2 & A_{mm} \end{pmatrix}$$

where $A_{00} = Q - \Lambda$, $A_0 = \Lambda$, $A_1 = Q - \mu I_n - \Lambda$, $A_{mm} = Q - \mu I_n$, $A_2 = \mu I_n$. $A_{00}, A_{10}, A_0, A_1, A_2, A_{mm}, I_n \in \mathbb{R}^{n \times n}$, and I_n is the identity matrix.

$Z(t)$ is a finite QBD (Quasi Birth Death) process whose solution has been studied in many papers [47–50]. We adopt the solution proposed by Krieger et al. [49], the Improved Logarithmic Reduction Algorithm (ILRA).

6. Performance evaluation

The comparison of Table 4 with Tables 2 and 3 indicates that the proposed MMPP model captures the LRD characteristics of the traffic we measured at the edge router interconnecting the Politecnico di Torino network to GARR/B-TEN. This is hardly a surprise, since we tuned the model to obtain this result. However, it indicates that the proposed MMPP model is capable of exhibiting LRD behaviors over the time scales of interest. In this section we further evaluate the performance of the proposed MMPP model in two ways: (i) we study the behavior of the synthetic traffic produced by the MMPP model when feeding a buffer in front of a transmission link, and compare the results against those produced by measured traffic traces, (ii) we investigate the predictability and tunability of the model when used as a synthetic source of aggregate Internet traffic, i.e. we discuss the model effectiveness in representing different traffic scenarios.

The analysis in this section considers the 2001 traces, for which the values of the measured parameters are reported in Table 5.

6.1. Queuing analysis

In order to evaluate the accuracy of the model as a synthetic traffic source, we consider a queuing system and we compare the performance obtained by feeding the queue with the synthetic traffic generated by the MMPP model with the results obtained from the real trace. For comparison purposes only, and in order to show the importance of introducing some memory in the input traffic model, we also plot the queue performance obtained when Poisson traffic feeds the queue.

We first consider the case of infinite buffer. The service time distribution reflects the packet length distribution measured from the real traces, which is reported in Fig. 7, and exhibits the well-known multi-mode behavior, with

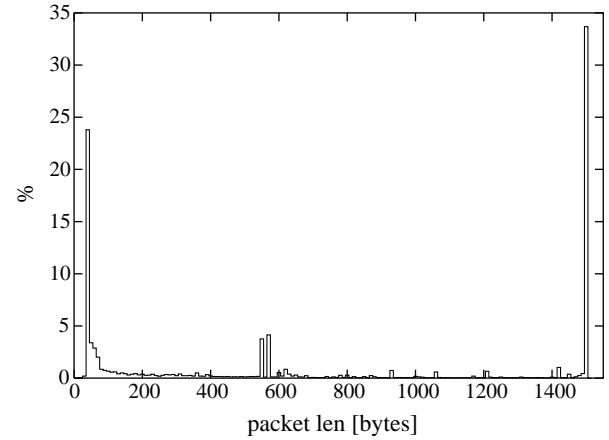

Fig. 7. Packet length distribution used in simulations.

peaks for very short packets and for the different MTUs (Maximum Transfer Units) in the network, with a dominating peak at 1500 bytes, due to the size of Ethernet frame. To evaluate the performance of the queue under different values of the load, we change the service rate (in bit per seconds) while keeping the packet length distribution unchanged. Notice that the load of the queue has no relation with the actual load of the link where the traces were collected. The results for the synthetic traffic are obtained by simulating the corresponding MMPP/GI/1 queue.

Fig. 8 reports the queue length distribution for the Peak'01 trace. The thin dashed line is obtained by using as input the measured trace, the solid line is obtained with the MMPP model and the thick dashed line with a simple Poisson process whose rate matches the average packet arrival rate measured on the trace. Plots refer to four different loads: 0.9, 0.8, 0.7, and 0.6. For the real trace, the tail of the distributions below 10^{-4} becomes noisy due to lack of samples. The buffering behavior of the model matches quite well that of the measured traces, while, as expected, the Poisson model underestimates the buffer level of orders of magnitude. Notice that the accuracy of the MMPP model predictions tends to increase for large values of the load, which correspond to the most interesting cases for the system designer.

Similar results are shown in Fig. 9 for the Night'01 trace. In this case, the accuracy of the model is less satisfactory, especially when the load is light. It must be noted, however, that this scenario is both less interesting and somewhat more 'artificial' than the previous one. First of all, the number of points in the measured trace is about 50 times smaller than during peak hours (see Table 1) and this explains why trace-driven curves are noisier. Second, the real link load at night is extremely low, thus artificially forcing the load to values higher than 0.6 significantly modifies the overall scenario. Yet, despite of this, the MMPP model matches quite well the tail of the distribution, which is typically the most crucial part of the curve.

Table 5
Measured values from real traces used in setting the model parameters

	Peak'01	Night'01
\hat{N}_p	22.03	14.35
$\hat{\lambda}_p$	29.57	352.9
$\hat{\Lambda}_f$	49.95	2.78
$\hat{\Lambda}_p$	1113.0	40.06

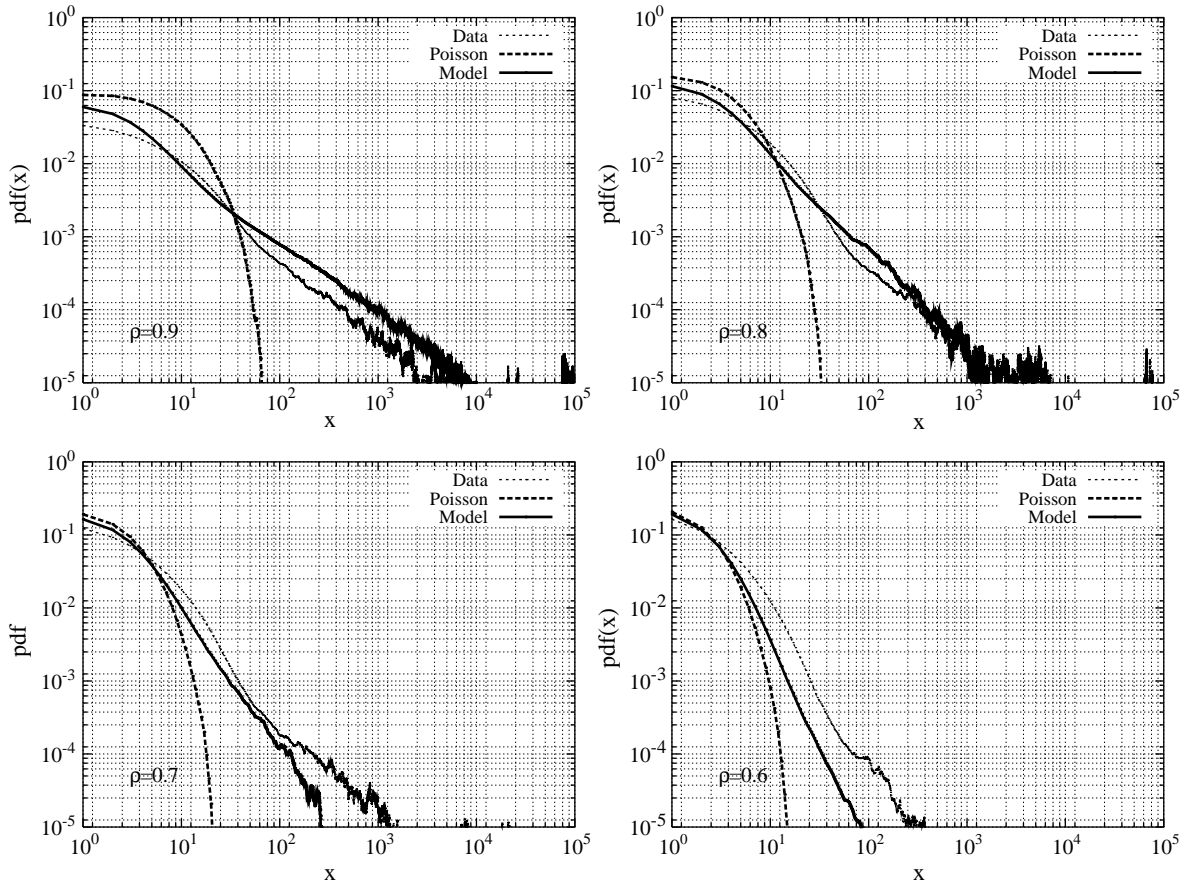

Fig. 8. Buffer occupancy distribution for the model, the Peak'01 trace and Poisson arrivals; load $\rho=0.9, 0.8, 0.7$ and 0.6 .

We now look at the case of finite buffers. The results for the MMPP model are derived analytically, by assuming that service times are exponentially distributed. Fig. 10 reports the queue length distribution for a finite buffer queue driven by the same arrival process as in the previous scenarios for the Peak'01 trace, with $\rho=0.9$. The considered buffer sizes are $B=32, 64, 128, 256, 512$ packets. Notice again the accuracy of the model in evaluating the queue performance. The curves for the Poisson traffic with different values of the buffer size cannot be distinguished from one another.

We now consider the typical dimensioning problem: the evaluation of the impact of the buffer size on the packet loss probability. Results are shown in Fig. 11. Two curves refer to the MMPP model. The solid line reports analytical results obtained with the assumption that service times are exponentially distributed; the markers are derived from the model by simulation using the same distribution of the service time as for the real trace. The figure proves that the impact of the exponential assumption for service times is marginal. Again, notice that analytical predictions are very accurate.

In terms of complexity, the numerical approach depends mainly on the size of the matrices which describe the Markov process. The computation of the steady-state distribution of the MMPP is efficient because the matrix Q

is sparse, and finding the matrix geometric terms is also efficient thanks to the ILRA solution method, even for very large matrices. On the contrary, the computation of the boundaries can be a difficult task because it requires solving a dense linear system.

6.2. Sensitivity analysis

We now discuss the impact of the MMPP model parameters on both the Hurst parameters and the queuing behavior. In particular, we focus on the effect of the average number of flows per session, N_f , which represents the long-term memory of the model. We proceed as follows. We first derive the model parameters as described in Section 5.1. Then, we set a new value of N_f and, accordingly, we change λ_s so that the average number of flows generated in the time unit does not change. All the other model parameters are kept unchanged. Observe that the load is kept equal to the desired value (0.9) even if N_f is changed, as shown by the following equations:

$$\mathbb{E}[\Lambda_f] = \lambda_s + \lambda_f \mathbb{E}[n_s] = \lambda_s + \lambda_f \frac{\lambda_s}{\lambda_f} (N_f - 1) = \hat{\Lambda}_f \quad (10)$$

$$\mathbb{E}[\Lambda_p] = \mathbb{E}[\Lambda_f] N_p = \hat{\Lambda}_f N_p = \hat{\Lambda}_p \quad (11)$$

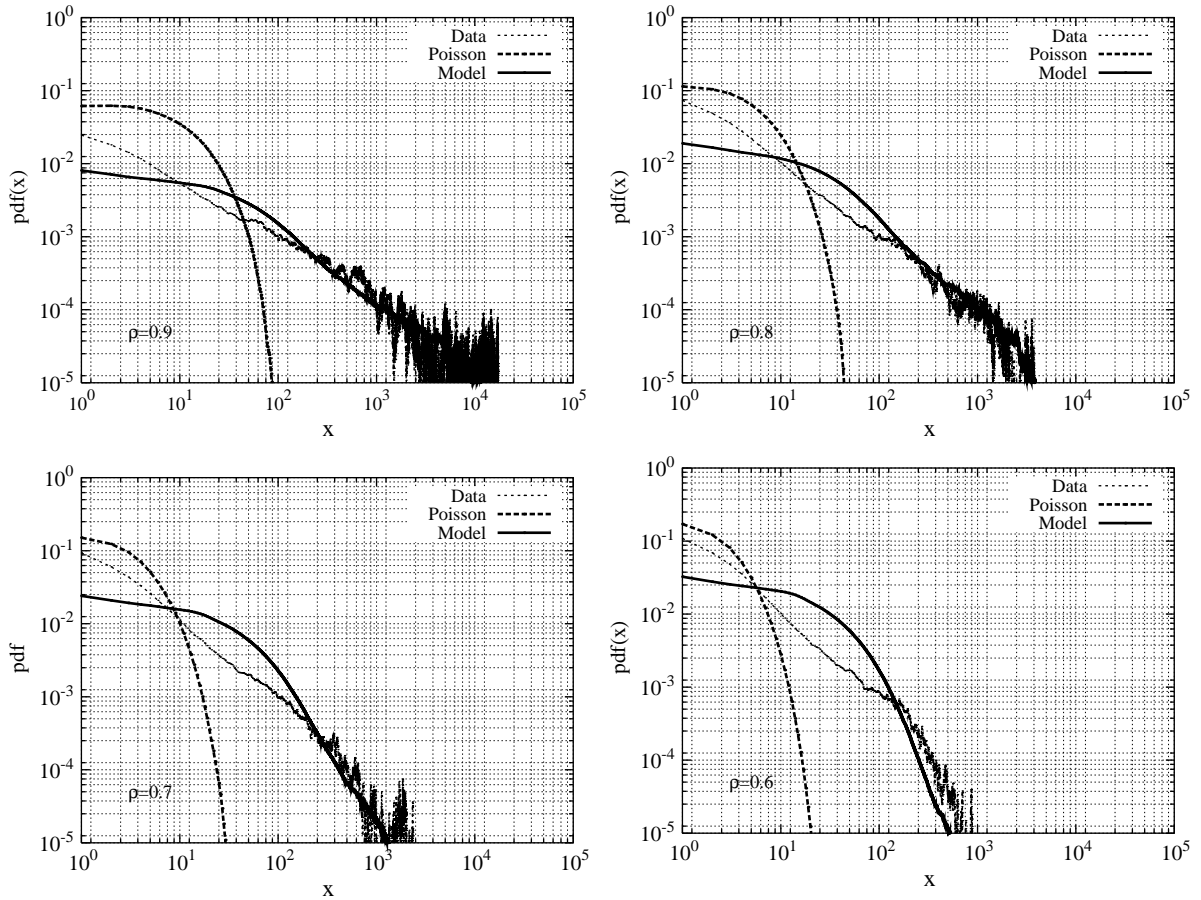

Fig. 9. Buffer occupancy distribution for the model, the Night'01 trace and Poisson arrivals; load $\rho=0.9, 0.8, 0.7$ and 0.6 .

This result is obvious, if we recall that N_f and C do not change the first order statistic but they act only on the second order statistics. Results are shown in Fig. 12 for different values of N_f . Again, for comparison purposes only, we report the curve derived with Poisson packet arrivals. The case $N_f=1$ corresponds to one flow only per session,

which implies that the flow arrival process is Poisson. Increasing the number of flows per session makes the queue tail heavier: as N_f increases, the range where the queue decay follows roughly a power law becomes longer. Clearly, there is always a value beyond which the queue decay is exponential and this value increases with N_f .

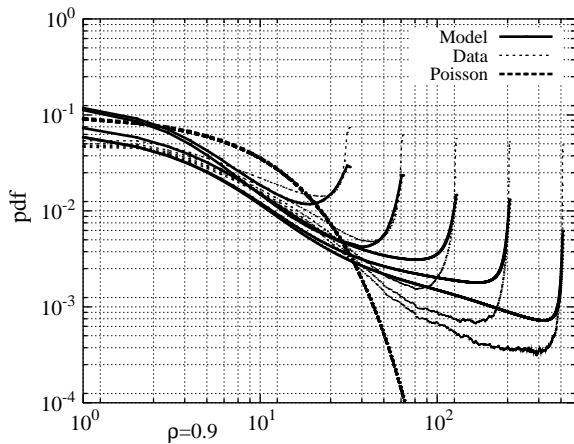

Fig. 10. Buffer occupancy distribution for the model, the Peak'01 trace and Poisson arrivals; finite buffer with capacity equal to 32, 64, 128, 256, 512 packets and load $\rho=0.9$.

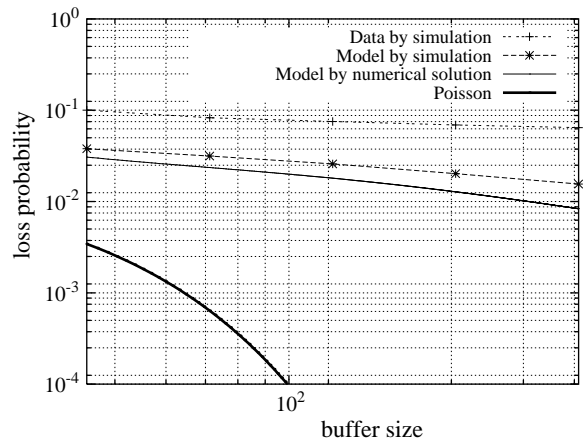

Fig. 11. Buffer loss probability for the model, the Peak'01 trace and Poisson arrivals; finite buffer with capacity equal to 32, 64, 128, 256, 512 packets and load $\rho=0.9$.

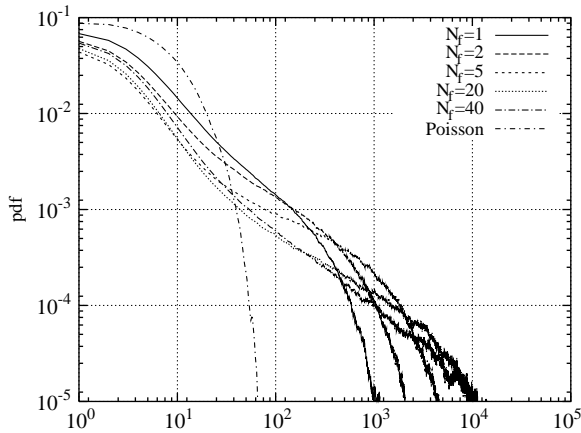

Fig. 12. Buffer occupancy distribution for the model with different values of N_f ; offered load equal to 0.9.

Indeed, the behavior of our model confirms the results obtained in [51], where the Hurst parameter of measured traffic, as well as the queuing behavior of the same traffic, are fitted through the use of phase type distributions.

Thanks to its simplicity and to the intuitive meaning of the parameters, the model can be effectively used as a manageable tool for IP network dimensioning and design. Indeed, having proved that the model accurately represents real traffic behavior, the model can be used to assess the performance of a system under variable traffic conditions, by simply changing the value of the parameters. Consider for example that for the network design we are interested in evaluating the impact of different traffic mixes on a finite buffer. We fix a value of N_f and modify accordingly N_p so that the average offered load to the buffer is constant. This corresponds to traffic mixes composed by either a small number of long flows or a large number of short flows. Fig. 13 plots the loss probability for a finite buffer of 512 packets, and for average load equal to 0.7, 0.8, 0.9. The figure shows that the loss probability initially increases for increasing values of N_f , but for values of N_f larger than about

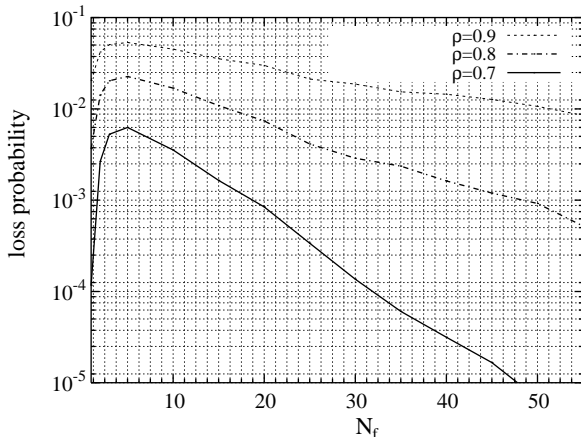

Fig. 13. Loss probability with different values of N_f ; buffer size equal to 512.

5, the loss probability decreases. Indeed, the loss probability is strictly related to the correlation in the packet arrival process: for N_f close to one (and therefore for large values of N_p), we expect less correlation in the traffic mix, having just one long flow per session, i.e. flows and sessions tend to coincide. Similarly, large values of N_f force small values of N_p , which leads to many one-packet long flows, i.e. flows and packets tend to coincide, thus reducing correlation.

7. Conclusions

In this paper, we proposed a simple MMPP Internet traffic model that is capable of approximating well the traffic characteristics measured at the edge router of our institution. The model is based on a layered structure of sessions, that generate flows, that finally generate packets.

The characteristics of the synthetic traffic generated with the model match the LRD characteristics observed in the measured traces over the time scales of interest. One of the interesting features of the MMPP model is that it requires as inputs five parameters only. Three of these parameters can be directly mapped onto average traffic parameters, such as the average flow arrival rate, the average number of packets per flow, and the average arrival rate of packets within flows. The other two parameters define the notion of session, and are used to control the Hurst parameter of the synthetic traffic on the considered scaling range.

Most interesting is that the behavior of the synthetic traffic in a queue with either finite or infinite buffer matches very well the behavior of the measured traces. Thus, the proposed MMPP model can be considered an accurate descriptor of aggregate Internet traffic, and can be effectively used to dimension buffer sizes and link capacities.

The key features of the proposed MMPP model are its simplicity and its intuitive structure. While, on the one hand, these features allow an accurate match of the characteristics of measured traffic, on the other hand, they allow the model to be used by traffic engineers with only limited knowledge of the sophisticated theoretical aspects of LRD processes.

References

- [1] W.E. Leland, M.S. Taqqu, W. Willinger, V. Wilson, On the self-similar nature of ethernet traffic (extended version), *IEEE/ACM Transaction on Networking* 2 (1) (1994) 1–15.
- [2] V. Paxson, S. Floyd, Wide-area traffic: the failure of poisson modeling, *IEEE/ACM Transactions on Networking* 3 (3) (1995) 226–244.
- [3] M.E. Crovella, A. Bestavros, Self-similarity in world wide web traffic: evidence and possible causes, *IEEE/ACM Transaction on Networking* 5 (6) (1997) 835–846.
- [4] W. Willinger, M.S. Taqqu, R. Sherman, D.V. Wilson, Self-similarity through high variability: statistical analysis of ethernet LAN traffic at the source level, *IEEE/ACM Transaction on Networking* 5 (1) (1997) 71–86.

- [5] M.E. Crovella, M.S. Taqqu, A. Bestavros, Heavy-tailed Probability Distributions in the World Wide Web, in: *A Practical Guide to Heavy Tails*, Chapman and Hall, New York, 1998, pp. 3–26 (Chapter 1).
- [6] D.R. Cox, Long-range dependence: a review in: H.A. David, H.T. David (Eds.), *Statistics: An Appraisal*, Iowa State University Press, Ames, IA, 1984, pp. 55–74.
- [7] A. Feldmann, A. Gilbert, W. Willinger, T. Kurtz, The changing nature of network traffic: scaling phenomena, *Computer Communication Review* 28 (2) (1998).
- [8] A. Erramilli, O. Narayan, W. Willinger, Experimental queueing analysis with long-range dependent packet traffic, *IEEE/ACM Transactions on Networking* 4 (2) (1996) 209–223.
- [9] A. Veres, M. Boda, The Chaotic Nature of TCP Congestion Control, in: *Proceedings of IEEE INFOCOM 2000*, Tel Aviv, Israel, March 2000, pp. 1715–1723.
- [10] A. Veres, Z. Kenesi, S. Molnar, G. Vattay, On the Propagation of Long-range Dependence in the Internet, in: *Proceedings of ACM SIGCOMM 2000*, Stockholm, Sweden, September 2000, pp. 243–254.
- [11] D.R. Figueiredo, B. Liu, V. Misra, D. Towsley, On the Autocorrelation Structure of TCP Traffic, Technical Report UMass-CMPSC-00-55, University of Massachusetts, Amherst, Computer Science Department, November 2000.
- [12] I. Norros, On the use of fractional Brownian motion in the theory of connectionless networks, *IEEE Journal on Selected Areas in Communications* 13 (1995) 953–962.
- [13] I. Norros, A storage model with self-similar input, *Queueing Systems* 16 (1994) 387–396.
- [14] H. Riedi, M.S. Crouse, V.J. Ribeiro, R.G. Baraniuk, A multifractal wavelet model with application to data traffic, *IEEE Transaction on Information Theory* 45 (4) (1999) 992–1018.
- [15] M. Taqqu, V. Teverosky, Is network traffic self-similar or multifractal? *Fractals* 5 (1) (1997) 63–73.
- [16] R.H. Riedi, J. Lévy Véhel, Multifractal Properties of TCP Traffic: A Numerical Study, INRIA Research Report 3129, February 1997.
- [17] S. Roux, D. Veitch, P. Abry, L. Huang, P. Flandrin, J. Mischeel, Statistical Scaling Analysis of TCP/IP Data, in: *Proceedings of IEEE International Conference on Acoustics, Speech, and Signal Processing (ICASSP'01)*, Special Session: Network Inference and Traffic Modeling, Salt Lake City, UT, USA, vol. 6, May 2001, pp. 3425–3428.
- [18] A. Feldmann, A.C. Gilbert, W. Willinger, Data Networks as Cascades: Investigating the Multifractal Nature of Internet WAN Traffic, in: *Proceedings of ACM SIGCOMM'98*, Boston, MA, USA, September 1998, pp. 42–55.
- [19] D. Veitch, P. Abry, P. Flandrin, P. Chainais, Infinitely Divisible Cascade Analysis of Network Traffic Data, in: *Proceedings of IEEE International Conference on Acoustics, Speech, and Signal Processing (ICASSP'00)*, Istanbul, Turkey, vol. 1, June 2000, pp. 245–248.
- [20] S. Ma, C. Ji, Modeling heterogeneous network traffic in wavelet domain, *IEEE/ACM Transaction on Networking* 9 (5) (2001) 634–649.
- [21] A. De Vendictis, A. Baiocchi, Wavelet Based Synthetic Generation of Internet Packet Delays, in: *Proceedings of International Teletraffic Conference ITC17*, Salvador, Brasil, December 2001.
- [22] A. Erramilli, R.P. Singh, An application of deterministic chaotic maps to model packet traffic, *Queueing Systems* 20 (1995) 171–206.
- [23] R.J. Mondragon, J.M. Pitts, D.K. Arrowsmith, Chaotic intermittency-sawtooth map model of aggregated self-similar traffic streams, *Electronic Letters* 36 (2) (2000) 184–186.
- [24] M. Krunz, A. Makowski, A Source Model for VBR Video Traffic Based on M/G/infinity Input Processes, in: *Proceedings of IEEE Infocom 98*, San Francisco, CA, USA, April 1998, pp. 1441–1448.
- [25] J.R. Gallardo, D. Makrakis, L. Orozco-Barbosa, Use of alpha-stable self-similar stochastic processes for modeling traffic in broadband networks, *Performance Evaluation* 40 (1–3) (2000) 71–98.
- [26] A. Horváth, M. Telek, A Markovian Point Process Exhibiting Multifractal Behavior and its Application to Traffic Modeling, in: *Proceedings of Fourth International Conference on Matrix-analytic Methods in Stochastic Models*, Adelaide, Australia, July 2002.
- [27] A.T. Andersen, B.F. Nielsen, A Markovian approach for modeling packet traffic with long-range dependence, *IEEE Journal on Selected Areas in Communications* 16 (5) (1998) 719–732.
- [28] P. Salvador, R. Valadas, A. Pacheco, Multiscale fitting procedure using markov modulated poisson processes, *Telecommunication Systems Journal*, Kluwer Academic Publishers 23 (1–2) (2003) 123–148.
- [29] S. Robert, J.Y. Le Boudec, On a Markov modulated chain exhibiting self-similarities over finite timescale, *Performance Evaluation*, Elsevier 27–28 (1996) 159–173.
- [30] S. Robert, J.Y. Le Boudec, Can Self-Similar Traffic be Modeled by Markovian Processes? in: *Proceedings of International Zurich Seminar on Digital Communication*, February 1996.
- [31] S. Robert, J.Y. Le Boudec, New models for pseudo self-similar traffic, *Performance Evaluation* 30 (1–2) (1997) 57–68.
- [32] A. Klemm, C. Lindemann, M. Lohmann, Modeling IP traffic using the batch Markovian arrival process, *Performance Evaluation* 54 (2) (2003) 149–173.
- [33] A. Reyes Lecuona, E. González Parada, E. Casilari, J.C. Casasola, A. Díaz Estrella, A Page-oriented WWW Traffic Model for Wireless System Simulations, *International Teletraffic Conference ITC16*, Edinburgh, UK, June 1999.
- [34] M. Grosslauer, J. Bolot, On the relevance of long-range dependencies in network traffic, *IEEE/ACM Transaction on Networking* 7 (5) (1999) 629–640.
- [35] S. Ben Fredj, T. Bonald, A. Proutiere, G. Régnié, J. Roberts, Statistical Bandwidth Sharing: a Study of Congestion at Flow Level, in: *Proceedings of ACM SIGCOMM 2001*, San Diego, CA, USA, August 2001, pp. 111–122.
- [36] T. Bonald, A. Proutiere, G. Régnié, J. Roberts, Insensitivity Results in Statistical Bandwidth Sharing, in: *Proceedings of International Teletraffic Conference (ITC) 2001*, San Paolo, Brasil, November 2001.
- [37] L. Muscariello, M. Mellia, M. Meo, R. Lo Cigno, M. Ajmone Marsan, An MMPP-Based Hierarchical Model of Internet Traffic, in: *Proceedings of IEEE ICC 2004*, Paris, France, vol. 4, June 20–24, 2004, pp. 2143–2147.
- [38] GARR—Rete dell'Università e della Ricerca Scientifica Italiana, <http://www.garr.it>, 2002.
- [39] S. McCanne, C. Leres, V. Jacobson, *Tcpdump*, <http://www.tcpdump.org>, 2002.
- [40] M. Mellia, A. Carpani, R. Lo Cigno, Tstat web page, <http://tstat.tlc.polito.it/>, 2002.
- [41] M. Mellia, A. Carpani, R. Lo Cigno, Measuring TCP and IP Behavior on a Edge Node, in: *Prof. of IEEE Globecom 2002*, Taipei, Taiwan, vol. 3, 2002, pp. 2533–2537.
- [42] M.S. Taqqu, Fractional Brownian motion and long range dependence in: P. Doukhan, G. Oppenheim, M.S. Taqqu (Eds.), *Theory and Application of Long-Range Dependence 2002*.
- [43] P. Abry, P. Flandrin, M.S. Taqqu, D. Veitch, Self-similarity and long-range dependence through the wavelet lens, in: P. Doukhan, G. Oppenheim, M.S. Taqqu (Eds.), *Theory and Application of Long-Range Dependence 2002*.
- [44] P. Abry, D. Veitch, Wavelet analysis of long range dependent traffic, *IEEE Transactions on Information Theory* 44 (1) (1998) 2–15.
- [45] Darryl Veitch Home Page, <http://www.emulab.ec.mu.oz.au/darryl/>
- [46] W. Fisher, K. Meier-Hellstern, The Markov-modulated Poisson process (MMPP) cookbook, *Performance Evaluation* 18 (1999) 149–171.
- [47] M.F. Neuts, *Structured Stochastic Matrices of M/G/1 Type and their Applications*, Marcel Dekker, New York, 1989.

- [48] G. Latouche, V. Ramaswami, A logarithmic reduction algorithm for quasi-birth-death processes, *Journal of Applied Probability* 30 (1993) 650–674.
- [49] U.R. Krieger, V. Naoumov, D. Wagner, Analysis Of A Finite Buffer, in: *An Advanced Packet-Switched Network*, IEICE Transaction On Communication, Vol. E00-B No. 5, Special Issue on ATM Traffic Control and Performance Evaluation, May 1998.
- [50] D. Bini, B. Meini, On cyclic reduction applied to a class of Toeplitz-like matrices arising in queueing problems, in: W.J. Stewart (Ed.), *Computations with Markov Chains*, Kluwer Academic Publisher, Boston, 1995, pp. 21–38.
- [51] A. Horváth, G.I. Rózsa, M. Telek, A map fitting method to approximate real traffic behaviour, in *Proceedings of Eighth IFIP Workshop on Performance Modelling and Evaluation of ATM and IP Networks*, Ilkley, UK, July 2000.