

# KISS: Stochastic Packet Inspection Classifier for UDP Traffic

Alessandro Finamore, Marco Mellia, Michela Meo, Dario Rossi <sup>†</sup>

Politecnico di Torino, Email: lastname@tlc.polito.it

<sup>†</sup> ENST Telecom Paris, Email: dario.rossi@enst.fr

**Abstract**—This paper proposes KISS, a novel Internet classification engine. Motivated by the expected raise of UDP traffic, which stems from the momentum of P2P streaming applications, we propose a novel classification framework which leverages on statistical characterization of payload.

Statistical signatures are derived by the means of a Chi-Square like test, which extracts the protocol “format”, but ignores the protocol “semantic” and “synchronization” rules. The signatures feed a decision process based either on the geometric distance among samples, or on Support Vector Machines. KISS is very accurate, and its signatures are intrinsically robust to packet sampling, reordering, and flow asymmetry, so that it can be used on almost any network.

KISS is tested in different scenarios, considering traditional client-server protocols, VoIP and both traditional and new P2P Internet applications. Results are astonishing. The average True Positive percentage is 99.6%, with the worst case equal 98.1%, while results are almost perfect when dealing with new P2P streaming applications.

**Index Terms**—Traffic classification, Supervised learning algorithms

## I. INTRODUCTION

Last years witnessed a very fast-paced deployment of new Internet applications, ignited by the introduction of the successful Peer-to-Peer (P2P) paradigm and fueled by the growth of Internet access rates. This entailed not only a deep change of the Internet application landscape, but also undermined the reliability of the traditional Internet traffic classification mechanisms, typically based on Deep Packet Inspection (DPI) as for instance simple port-based classification.

As such, research on Internet traffic classification has gained significant attention, with a large number of proposals (see Sec. VI for an overview) that try to circumvent DPI limitations. Indeed, DPI is deemed to fail more and more due to: i) proliferation of proprietary and evolving protocols, ii) embracement of strong encryption techniques and iii) adoption of tunneling techniques [1], [2]. In previous proposals, UDP has usually been neglected in favor of applications running over TCP. Motivated by the raise of UDP traffic volume, which stems from the momentum of VoIP, streaming and P2P-TV applications that deeply rely on UDP at the transport layer, we propose a novel classification framework that explicitly targets long-lived UDP traffic flows.

This work was funded by the European Commission under the 7th Framework Programme Strep Project “NAPA-WINE” (Network Aware Peer-to-Peer Application under Wise Network) and by a Cisco Collaborative Research Initiative (CCRI) named “Protocol Oblivious (Behavioral) Internet Traffic Classification”. A preliminary version of this paper appeared in [3].

The mechanism we propose is based on the idea of automatically identifying the application protocol “format”, by means of a statistical packet inspection. This already proved successful in assisting the identification of particularly tricky traffic such as the one generated by Skype [2]. In this paper, we push this intuition further, arguing that, due to the connectionless service of UDP, the very first bytes of the UDP payload of traffic streams are likely to carry some application layer protocol (L7-protocol), in which constant values, counters, random identifiers, etc., can be found. Recalling that a protocol specifies the rules governing the *format*, *semantics* and *synchronization* of a communication, we propose to extract the L7-protocol *format* while ignoring the actual semantic and synchronization rules. This is achieved by statistically characterizing the frequencies of observed values in the UDP payload, by performing a test similar to the Pearson’s  $\chi^2$  test. The results of the test are then used to compactly represent application fingerprints, which we call Chi-Square Signatures (pronounced as KISS).

While KISS fingerprints stem from packet inspection, they have several advantages over classical DPI signatures:

- They can be automatically derived, i.e., no cumbersome and tedious reverse engineering is required;
- They can be quickly updated, so that they are well apt to the context of fast-evolving Internet applications;
- They are easily portable across different network settings, since fingerprints depend solely on the L7-protocol format;
- They are robust to routing asymmetry, packet loss or sampling, retransmission, or any possible strange packet arrival pattern, since they are build over a statistical characterization of protocol format rather than over a deterministic description;
- They are suitable to both per-flow and per-endpoint classification;
- Their computational and memory requirements are very limited, so that they are suitable for on-line classification.

However, KISS shares with DPI classifier the need to look at application layer messages. As a drawback, in case of encrypted payload, both approaches become ineffective.

After that fingerprints have been extracted, proper classification must be achieved, i.e., individual items should be placed into the most likely class. A huge set of methodologies are available from the literature, from simple threshold based heuristics [4], to Naive Bayesian classifiers [2], [5], to

advanced statistical classification techniques [6]. In this paper, we compare a simple geometric decision process based on Euclidean distance with Support Vector Machines (SVMs) [6], which are well known in the statistical classification field, but have been rarely exploited in the context of Internet traffic classification.

To prove the performance of the proposed framework, we implemented KISS in Tstat [7], which then we use to derive the results presented in this paper. We test KISS on both testbed and real traffic traces, collected from an operative ISP network classifying traditional protocols (like DNS and RTP traffic), affirmed P2P protocols (like eMule, BitTorrent and Skype) and emerging P2P-TV applications (like PPLive, SopCast, Joost, TVants). KISS exhibits excellent performance, typically achieving more than 98.1% of True Positives when SVM is adopted. These astonishing results are due to both the accurate characterization of the KISS signatures and the precise classification of the SVMs.

The reminder of the paper is organized as follows. Sec. II introduces general concepts and specify the metrics chosen to evaluate KISS performance. Sec. III describes the KISS architecture, detailing both feature extraction and decision processes. Sec. IV describes the set of traces used in the experiments and Sec. V reports a deep investigation of KISS, testing its performance and parameters in many different scenarios. An overview of other classification techniques is presented in Sec. VI while Sec. VII concludes the paper.

## II. GENERAL FRAMEWORK

Before entering into the details of KISS, we briefly summarize the key ideas behind classification tools and the methodologies to test them and evaluate their performance.

### A. Classifiers

Classifiers are defined by two main processes (see [6], [8] for a more extended description):

- Feature extraction: the process of extracting the subset of information that summarizes a large set of data, or samples.
- Decision process: the algorithm that assigns a suitable class to an observed sample.

Examples of features are specific strings in the payload (as in DPI), or packet size, or amount of exchanged bytes. Potentially, any summary of a packet stream can be used and its choice has a deep impact on the classifier performance. In our tool, features are defined from the statistical observation of the values taken by portions of the payload.

For the decision process, any machine learning technique can be adopted; in this paper we focus on *supervised learning algorithms* [6], in which a training set composed of known traffic is used to build a model; the model is then used during the classification task. Given a geometric representation of features in a multidimensional space, during the training phase, labeled samples are used to identify and to define the “volume” in which samples of the considered class fall into. During the classification process instead, the sample to be classified has to be labeled with the most likely class according to the volume it

TABLE I  
DEFINITION OF FALSE/TRUE POSITIVE AND FALSE/TRUE NEGATIVE

Classification Result	Oracle Classification	
	True	False
	Positive	True Positive
Negative	False Negative	True Negative

falls into. For example, assuming that there are two classes of objects, i.e., red and yellow apples, if the features of a sample place it in an volume dense of red apples, we are inclined to classify it as a red apple too. However, defining the surface that delimits the volumes (to later take the decision) is tricky, since training points can be spread out on the multidimensional space and complex surfaces must be described. In this paper, we consider both simple geometric decision process and SVM based algorithm, which is considered to be among the most powerful supervised learning algorithms.

### B. Testing methodology

Once a classifier has been designed, its performance must be evaluated and proper metrics must be defined. Assessing the performance of Internet traffic classifiers is not a trivial task due to the difficulty in knowing the “ground truth”, i.e., what was the actual application that generated the traffic [9]: for the ground truth, an “oracle” is needed. Testing the classification engine by means of artificial traffic (e.g., by generating traffic in a testbed) solves the problem of knowing the ground truth (you are the oracle), but reduces the representativeness of the experiments, since synthetic traces are hardly representative of real world traffic. Assessing the performance against traffic traces collected from operative networks is therefore mandatory. To extract the ground truth from the real traces we developed an ad-hoc oracle, based on DPI mechanisms, and we manually tuned and checked whose results. However, the oracle may still be fooled.

Classification accuracy is often reported in terms of False Positive (FP) and True Positive (TP), and the False Negative (FN) and True Negative (TN). A test is said “True” if the classification result and the oracle are in agreement. A test is said “False” on the contrary. The result of a test is “Positive” if the classifier accepts the sample as belonging to the specific class. On the contrary a test is “Negative”. For example, consider a flow. The oracle states that this flow is an eMule flow. If the flow is classified as an eMule flow, then we have a True Positive. If not, then we have a False Negative. Consider instead a flow which is not an eMule flow according to the oracle. If the flow is classified as an eMule flow, then we have a False Positive. If not, then we have a True Negative. Table I summarizes the definitions.

The corresponding percentages must be evaluated as

- False Positive Percentage (%FP) is the percentage of *negative* samples that were erroneously reported as being positive:

$$\%FP = 100 \frac{FP}{Total\ Number\ of\ Negative\ Samples};$$

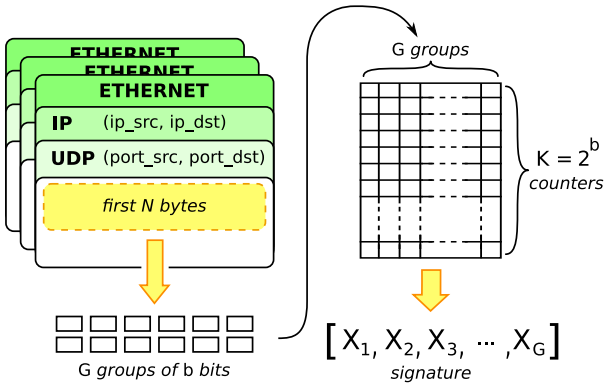

Fig. 1. Scheme of signature extraction process.

- False Negative percentage (%FN) the proportion of *positive* samples that were erroneously reported as negative:

$$\%FN = 100 \frac{FN}{\text{Total Number of Positive Samples}};$$

- True Positive Percentage (%TP) is 100-%FN;
- True Negative Percentage (%TN) is 100-%FP;

Indeed, if there are 100 eMule flows and the classifier misses 10 of them, we have %FN=10% (%TP=90%). Similarly, if there are 500 non eMule flows and the classifier returns all of them as eMule, we have %FP=100% (%TN=0%).

Finally, results are often expressed by means of a *Confusion Matrix*. In the field of artificial intelligence, a confusion matrix is a visualization tool typically used in supervised learning. Each column of the matrix represents the instances in a predicted class, while each row represents the instances in an actual class. One benefit of a confusion matrix is that it is easy to see if the system is confusing two classes (i.e., commonly mislabeling one as another).

### III. KISS

#### A. Feature Extraction

A traditional DPI classifier inspects packet payload looking for *deterministic patterns*, such as particular strings which are compared to those in a signature database. The process of defining the signatures is a complex task that requires a deep knowledge of the protocols that need to be identified. As such, any changes in a protocol can invalidate the signature, which becomes outdated and must be redefined manually.

The goal of KISS is instead to *automatically discover application layer header format*, without caring about specific values of the header fields: we aim at automatically let the protocol format emerge. Since UDP is a connectionless protocol, the first bytes of the payload of each UDP packet typically contain an application layer protocol header whose fields can be constant identifiers, counters, words from a small dictionary (message/protocol type, flags, etc), or truly random values (coming from encryption or compression algorithms). These coarse classes of fields can be easily distinguished through a simple statistical characterization of the values observed in a sequence of packets.

The process of the format extraction is achieved by using a simple Chi-Square like test. The test originally estimates the goodness-of-fit between observed samples of a random variable and a given theoretical distribution. Assume that the possible outcomes of an experiment are  $K$  different values and  $O_k$  are the empirical frequencies of the observed values, out of  $C$  total observations ( $\sum_k O_k = C$ ). Let  $E_k$  be the number of expected observations of  $k$  for the theoretical distribution  $E_k = C \cdot p_k$  with  $p_k$  the probability of value  $k$ . Given that  $C$  is large, the distribution of the random variable

$$X = \sum_{k=1}^K \frac{(O_k - E_k)^2}{E_k} \quad (1)$$

that represents the distance between the observed empirical and theoretical distributions, can be approximated by a Chi-Square, or  $\chi^2$ , distribution with  $K - 1$  degrees of freedom. In the classical goodness of fit test, the values of  $X$  are compared with the typical values of a Chi-Square distributed random variable: the frequent occurrence of low probability values is interpreted as an indication of a bad fitting. In KISS, we build a similar experiment analyzing the content of groups of bits taken from the packet payload we want to classify.

Chi-Square signatures are built from *streams* of packets. The first  $N$  bytes of each packet payload are divided into  $G$  groups of  $b$  consecutive bits each; a group  $g$  can take integer values in  $[0, 2^b - 1]$ . From packets of the same stream, we collect, for each group  $g$ , the number of observations of each value  $i \in [0, 2^b - 1]$ ; denote it by  $O_i^{(g)}$ . We then define a window of  $C$  packets, in which we compute

$$X_g = \sum_{i=0}^{2^b-1} \frac{(O_i^{(g)} - E_i^{(g)})^2}{E_i^{(g)}} \quad (2)$$

and collect them in the vector

$$\bar{X} = [X_1, X_2, \dots, X_G] \quad (3)$$

which is the KISS signature. Fig. 1 shows a schematic representation of the KISS signature extraction.

One possibility to characterize a given protocol is to estimate the expected distribution  $\{E_i^{(g)}\}$  for each group  $g$ , so that the set of signatures are created by describing the expected distribution of the protocols of interest. During the classification process then, the observed group  $g$  distribution  $\{O_i^{(g)}\}$  must be compared to each of the  $\{E_i^{(g)}\}$  in the database, for example using the Chi-square test to select the most likely distribution. However, this process ends up in a complex process in which Eq. (2) must be computed for each protocol of interest.

In addition to the high complexity, the comparison with reference distributions fails when the application protocol includes constant values which are randomly extracted for each flow. For example, consider a randomly extracted “flow ID” in group  $g$ . Consider two flows, one used for training and one for testing, generated by the same application. Let the training flow packets take the value 12 in group  $g$ . Let the test flow packets take instead the value 7 in the same group. Clearly, the comparison of the two observed distributions does not pass

the Chi-square test, and the test flow is not correctly classified as using the same protocol as the training flow.

For the above motivations, we propose to simply check the distance between the observed values and a reference distribution, which we choose as the uniform distribution, i.e.,  $E_i^{(g)} = E = \frac{C}{2^b}$ . In the previous example, the group randomness of the two flows has the same  $X_g$  values, that identify a “constant” value, independently of the actual value. In other terms, we use a Chi-Square like test to measure the randomness of groups of bits or as an implicit estimate of the source entropy.

To give the intuition of how Eq. (2) evolves versus  $C$ , consider the case in which a deterministic group of bits is observed. Since for a deterministic group only one value is possible, the value of  $X_g$  becomes:

$$X_g = \sum_{i=0}^{2^b-1} \frac{(O_i^{(g)} - E_i^{(g)})^2}{E_i^{(g)}} \quad (4)$$

$$= \sum_{i=0}^{2^b-1} \frac{(O_i^{(g)} - E)^2}{E} \quad (5)$$

$$= \frac{(C - E)^2 + (2^b - 1) E^2}{E} = C(2^b - 1) \quad (6)$$

Thus,  $X_g$  linearly increases with  $C$ .

In general, for a block in which  $b_0$  bits are constant, it can be shown that

$$X_g = C(2^{b_0} - 1) + 2^{b_0} \chi_A^2 \quad (7)$$

where  $\chi_A^2$  is the Chi-Square with  $A$  degrees of freedom. In this case,  $A = 2^{b-b_0} - 1$ .

To provide an example of the evolution of  $X_g$ , left plot in Fig. 2 reports the value of two 4-bit long groups belonging to two streams of two different traffic protocols, namely DNS and eMule, versus the number of collected packets  $C$ . The steep lines corresponding to groups taken from the eMule stream refer to fields that are almost constants. In this case, the longer the experiment is (larger  $C$ ), the larger the distance from the uniform distribution is, i.e., the bits are far from being uniformly distributed. In the same plot, observe the lines referring to DNS traffic. The lowest one has a very slow increase with  $C$ , its behavior is almost perfectly random, the values of  $X_3$  being compatible with those of a Chi-Square distribution. The bouncing line, instead, corresponds to the typical behavior of a counter. In fact, Eq. (2) over consecutive bits of a counter, cyclically varies from very low values (when all the values have been seen the same number of times) to large values. The periodicity of this behavior depends on the group position inside the counter.

While randomness provides a coarse classification over individual groups, by jointly considering a set of  $G$  groups through the vector  $\vec{X}$  the fingerprint becomes extremely accurate. Observe right plot in Fig. 2. Each point in the figure corresponds to a different stream. A window of  $C = 80$  packets is used to derive the signatures using the couple of features  $(X_2, X_3)$  as coordinates. Points obtained from DNS streams are displaced in the low left corner of the plot; points from eMule are spread in the top part of the plot. Notice also that signatures of the

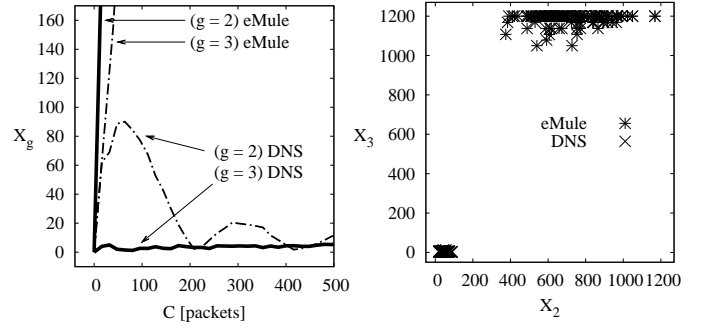

Fig. 2. Evolution in time (left) and dispersions in space (right) of  $X$  of two groups of 4 bits extracted from the second byte of UDP payloads.

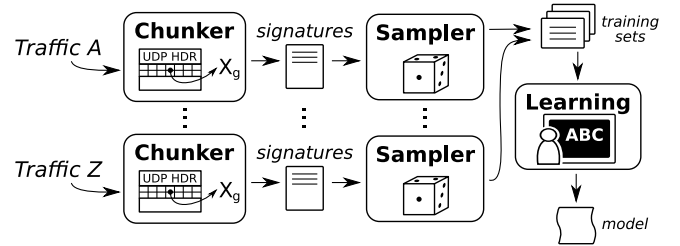

Fig. 3. Schematic representation of KISS learning steps.

same protocol class are not identical. This is due to both the behavior of each application and to different implementations of the same protocol. For example, some eMule clients can be downloading, uploading, or waiting, therefore exchanging different types of messages. Similarly, different implementations of a DNS server can use different random number generators to extract the query identifier. It is the scope of the decision process to define the areas where points of the same protocols are expected. Intuitively, different protocols fall in different areas that are clearly identified and easily separable: a simple straight horizontal line can effectively separate the two regions considering this example. However, when several protocols are considered, more complex surfaces have to be found.

## B. Decision Process

KISS is based on supervised machine learning decision process. During the training phase, we operate as sketched in Fig. 3. We start by considering some streams that belong to the set of applications we want to model. Streams are then fed into a *chunker*, whose role is to derive the KISS signatures as in Eq. (3). The signature set is randomly sampled by the *sampler*, so as to select the *training set*, whose size will be discussed in Sec. V-E. The training set is then fed to the learning system, after which the KISS model is produced. In this paper, we investigate two different learning systems, the first based on Euclidean distance and the second based on Support Vector Machines (SVM).

1) *Euclidean Decision Process*: A simple Euclidean distance is used for the decision process. A set of hyper-spheres, one for each protocol, is identified to define the areas in which

samples of each class are expected to fall. The classification process is then straightforward: a point that falls inside a sphere is classified according to the protocol associated to that sphere, while a point that does not fall into any sphere is assumed to be of an *unknown* protocol.

For a given class  $A$ , the representative hyper-sphere is fully defined by its center  $\bar{X}(A)$  and its radius  $\rho(A)$ .  $\bar{X}(A)$  is simply computed, component by component, as the arithmetic mean of each signature in the training set of class  $A$ . The identification of the radius is more complex. Indeed, the hyper-sphere should be big enough to include all the points of the training, but it has to be small enough to avoid to include samples of other classes. Using machine learning terminology, one wants to maximize the *True Positive* ratio while minimizing the *False Positive* ratio.

Formally, the following equation can be used to state the problem:

$$\rho(A) = \arg \max_{\rho} (\%TP(\rho) - \%FP(\rho)) \quad (8)$$

Recall that  $\%TP(\rho)$  is computed considering samples of class  $A$ , while  $\%FP(\rho)$  is computed considering samples of all other classes of the training set.

2) *SVM Decision Process*: SVM are a set of supervised learning methods used for classification and regression. The key idea of SVM is to displace the training samples (by means of a transformation from the original N-dimensional space to a possibly infinite-dimensional space) so that samples belonging to different classes can be separated by the simplest surface, i.e., an hyper-plane. SVMs exhibit a number of advantages:

- They are robust to the training set size and composition;
- Their computational and memory requirements are very limited during the classification phase, even if the training phase can be computationally expensive;
- They exhibit a very high discriminating power, so that they typically achieve very high classification accuracy;
- There is a large number of efficient algorithms and implementations already available. In particular, in this paper we adopted the LIBSVM [10] implementation.

Finally, notice that the output of the SVM training phase is a definition of a number of regions equal to the number of classes defined during the training phase, e.g., one for each protocol that is offered during the training phase. This implies that a sample will then always be classified as belonging to one of the known classes. Considering traffic classification, an additional region is needed to classify all samples that do not belong to any of the given protocols, i.e., to represent *unknown* protocols. Thus, the training set must contain two types of signatures: i) the ones referring to traffic generated by the applications to classify; ii) the ones representing all the remaining traffic. We refer to this second class as *Background* since it represents the set of applications that we cannot classify or are not interested in classifying.

#### IV. TESTING DATASET

We aim at assessing KISS performance in the most difficult scenario, whenever possible. For most of the results we show,

we consider real traffic traces, collected from an operative, totally uncontrolled network. In addition, to evaluate the performance of KISS when dealing with new protocols, we also selected, as a case study, P2P-TV applications. Indeed P2P-TV systems have been recently introduced and they are starting to become popular. These applications rely on proprietary design and protocols, they preferentially use UDP as transport protocol, and they are expected to offer a large amount of traffic to the network; thus, their classification is going to be the more and more important.

##### A. Classification Objects

We consider the scenario in which a network provider or administrator is interested in knowing the traffic that is going to or coming from a set of internal hosts. In this context, we define a classification entity as

- *flow* if all packets are coming from the same source IP address and UDP port and are going to the same destination IP address and UDP port;
- *endpoint* if all packets having the same IP destination (source) address and UDP destination (source) port.

Indeed, depending on the application, one can be interested in identifying a single flow (as in the case of a VoIP stream), or in detecting an endpoint and therefore all packets sent/received from it (as in the case of a P2P application).

##### B. Testing Datasets

*Real Traffic Traces*: Real traffic traces (RealTrace) were collected from the network of FastWeb [12], an ISP provider that is the main broadband telecommunication company in Italy, offering converged services, in which data, native VoIP [13] and IPTV services share a single broadband connection. The FastWeb network is a very heterogeneous scenario, in which users are free to use the network without any restriction. It therefore represents a very challenging scenario for traffic classification. A probe node based on high-end PC running Linux has been installed in a PoP located in Turin, in which more than 500 users are connected, using more than 2000 different IP addresses (e.g., VoIP phones, set-top-boxes, PCs, etc.). All packets entering/leaving the PoP have been captured. The measurements presented in this paper refer to two datasets that we call RealTrace-I and RealTrace-II, collected in 2006 and 2007 <sup>1</sup>.

Both traces contain many popular applications generating UDP traffic, in particular we selected: i) eMule and Bittorrent, ii) VoIP (over RTP) and iii) DNS protocols. Indeed, these three protocols account for more than 80% of UDP endpoints, corresponding to 95% of the flows and to more than 96% of the total UDP volume. In the remaining traffic, nearly 2% of flows are related to BitTorrent accounting for less than 1% of bytes. Skype communications instead present the typical mice/elephant behavior since a negligible number of flows account for more than 1% of the total volume in both traces. Being dated back to 2006 and 2007, no P2P-TV traffic is present.

<sup>1</sup>Due to a NDA, we are not allowed to show results referring to more recent traces. Nonetheless, we can affirm that this trace is representative of typical KISS performance.

TABLE II  
DESCRIPTION OF THE DATA TRACES

	Bytes	Packets	Flows	Endpnts	Time period
RealTrace-I	53.13G	321M	18.25M	1.72M	22h, May '06
RealTrace-II	31.33G	133M	5.25M	1.02M	12h, Jun '07
P2Ptrace	10.25G	14M	132K	48.5K	3h, Apr '08
Skype	3.7G	24.7M	966	559	96h, May '06

*P2P-TV Traces:* To assess the performance of KISS with P2P-TV traffic, we selected, among the available P2P-TV applications, PPLive, Joost, SopCast and TVants. Since none of the selected applications was available at the time of real traffic trace collection, we are forced to rely on testbed P2P-TV traces, called P2Ptrace, to assess the performance of KISS. This dataset of traces has been collected in the context of Napa-Wine [14] project, in which a large scale experiment was organized to observe the performance of the above mentioned P2P-TV applications. The resulting dataset consists of packet level traces collected from more than 45 PCs running P2P-TV applications in 5 different Countries, at 11 different institutions. The dataset includes traces collected from PCs in Campus LANs, Corporate networks with restrictive policies, home ADSL connections, so that both nodes with public and private IP addressing are present. We are therefore confident that the heterogeneity of the P2Ptrace dataset is representative of a wide range of different scenarios.

*Skype Traces:* In the tests, we also use the public available dataset for the Skype traffic [11]. The dataset contains both Skype traffic identified in [2] and traces collected in a controlled environment using PCs running different versions of Skype and different operating systems such as Windows, Linux and Pocket-PC.

Tab. II summarizes the previously described datasets and reports the total amount of bytes, packets, flows and endpoints for each dataset and the collection time and duration of each trace.

We assume packets belonging to the same flow/endpoint are exposed to the KISS engine, so that after digesting  $C$  packets, a classification decision is taken and a new observation window begins. Therefore, several classification decisions are possibly taken for a single flow or endpoint. In this paper, we consider independent classifications, so that the same flow/endpoint can be classified differently at each window. Notice that some reconciliation algorithm can be easily designed to increase the accuracy of the classification by considering the set of classifications involving the same flow or endpoint, e.g., adopting a majority criterion. We leave this issue to future work.

Notice that i) no assumption about observing the first set of packets is stated; ii) there is no need to observe bidirectional streams of packets; and iii) not all packets belonging to the same flow/endpoint must be exposed to the classifier; possible packet drop, reordering, sampling can be present.

### C. The Oracle Definition

To obtain the ground truth from an *Aggregated* trace, i.e. a traffic trace with a mixture of communications of different

protocols, we developed a DPI classifier that was explicitly designed. It was implemented in Tstat [7], and its performance were manually fine tuned and double checked. In particular, DPI rules can be summarized as follow:

- DNS: we rely on simple port-based classification and a manual inspection as to identify only the flows with respect to DNS RFC1035;
- RTP/RTCP: we rely on the state machine described in [13]. It combines a DPI signature and correlates the value of the fields in consecutive packets (e.g., to check the validity of the counters).
- eMule/BitTorrent: we developed a DPI classifier based on [15], [16] adapting it to the considered scenario.
- Skype: we rely on the Bayesian framework described in [2].

All the aggregated traffic that do not match any of the rules is placed in a sub trace called *Background* since it represents all the *Unknown* protocols.

Since the oracle itself can be unreliable, accurate manual inspection and pinpointing of suspect cases are detailed in the performance results.

## V. RESULTS

### A. Real Traffic Traces

We first report results considering a small subset of the RealTrace-I dataset, corresponding to the first 1 hour of traffic. The oracle is used to split the trace into 4 sub traces: each sub trace includes only packets classified as belonging to the same protocol, i.e., RTP, eMule, DNS and Background traffic only. Each trace is fed to the KISS classifier, so that signatures are evaluated. Both SVM and Euclidean decision processes are trained using 300 signatures for each class and the remaining signatures are used to assess the performance of KISS. Recall that a signature is generated every  $C$  samples, so that a flow/endpoint can be classified several times (i.e., every  $C$  packets).

Tab. III summarizes the results. Each row corresponds to a class of traffic according to the oracle. The second column reports the total number of signatures extracted from each sub trace while the remaining columns report the percentages of True Positives and False Positives for both Euclidean and SVM decision process.

The SVM results are astonishing: the True Positives are always higher than 99% while False Positives are negligible. The performance of the Euclidean classifier are more variable, e.g., it performs very well for RTP but the accuracy decreases when considering eMule and DNS protocols. This is related to the adoption of an hyper-sphere as an approximation of the separation surface between classes. To this extent, Fig. 4 reports Eq. (8) as an examples of optimization for RTP, eMule and DNS. For RTP, any choice of  $\rho(RTP) \in [12.2, 28.0]$  allows to almost perfectly identify RTP traffic. On the contrary, eMule class is not well represented by the hyper-sphere surface, so that any choice of  $\rho(eMule)$  trades between %TP and %FP. Similar reasoning applies for DNS traffic. This shows that a simple decision process based on Euclidean distance is hard to design, while the adoption of SVM allows to avoid

TABLE III  
EUCLIDEAN AND SVM PERFORMANCE ON REALTRAFFIC TRACES

	Euclidean			SVM	
	Tot.	%TP	%FP	%TP	%FP
RTP	8386	99.9	-	99.9	-
eMule	1527	84.3	0.12	99.3	-
DNS	8245	91.3	-	99.9	0.01
Backg	2579	99.1	5.31	99.6	0.15

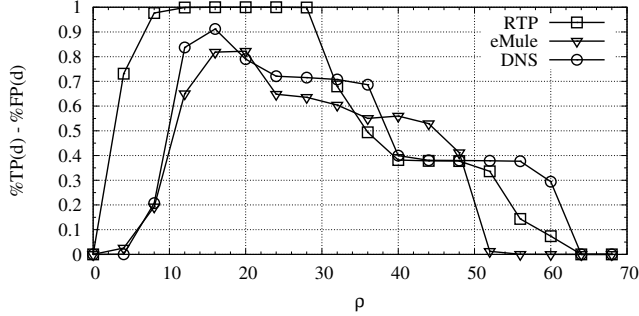

Fig. 4. Euclidean Decision Process: True Positive - False Positive evolution of versus  $\rho$  for RTP, eMule and DNS classes.

this problem. This conclusion is supported by other tests we performed, not reported here for the sake of brevity. Therefore, in the following we will consider only the SVM classifier and we will investigate how KISS performance are affected by parameters setting and different scenarios.

### B. P2P-TV traffic traces

To prove the KISS flexibility, we explore its ability to identify traffic generated by P2P-TV applications. The design and engineering of a DPI mechanism for proprietary and closed P2P-TV applications would be daunting and extremely expensive. On the contrary, training KISS is quite straightforward: a packet trace is captured by simply running the target application and then it is used to train the SVM. RealTrace-I instead is used as Background class. In this way, all traces from the P2PTrace dataset are used to evaluate %TP while RealTrace-I is instead used to evaluate the %FP, since we assume no P2P-TV traffic could be present during 2006. The total amount of time required to complete this task is less than 6 hours.

Results are summarized in Tab. IV, which reports percentages computed over more than 1.2 millions of tests. Labels on the rows represents the ground truth. Also in this case, results are amazing. KISS is able to correctly classify more than 98.1% of samples as True Positives in the worst case and only 0.3% of False Positives are present.

### C. Signature Robustness

We are first interested in quantifying KISS robustness respect to a training set independent from the test set. We thus perform an experiment in which the SVM is trained using samples extracted from the initial part of the RealTrace-I. A 9-hour long subset of RealTrace-I is considered, but the

TABLE IV  
CONFUSION MATRIX CONSIDERING P2P-TV APPLICATIONS

	Tot.	Joost	PPLive	SopCast	TVants	Aggr.
Joost	33514	98.1	-	-	-	1.9
PPLive	84452	-	100.0	-	-	-
SopCast	84473	-	-	99.9	-	0.1
TVants	27184	-	-	-	100.0	-
Aggr.	1.2M	0.3	-	-	-	99.7

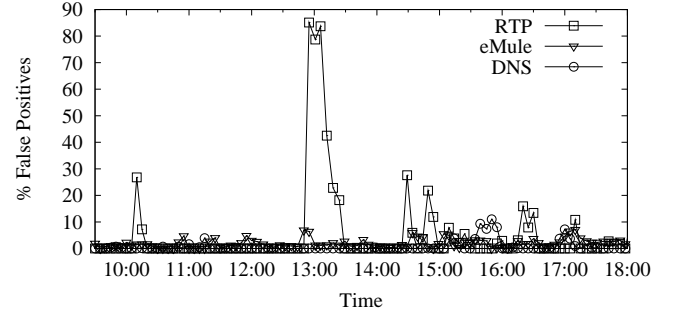

Fig. 5. False Positive percentage variation versus time. Background in the training set.

training set includes samples extracted from the first 30 minutes only. As in experiment V-A, only RTP, eMule, DNS and Background are considered in the SVM model. Results are reported in Fig. 5 showing only Background False Positive percentages since the %TP is always higher than 99%. The plot confirms the intuition that the characterization of the Background traffic may be a problem, since there are peaks that clearly show that the SVM is fooled by the sudden appearance of unknown protocols that were not included in the training set.

Investigating further, we notice that the high percentage of Background traffic classified as RTP traffic is due a single endpoint which is receiving traffic with the same “format” of RTP protocol. However, the DPI based oracle did not classify this endpoint as RTP, since a mismatch in the RTP header is present: the RTP version field takes a values of 1 instead of 2. Apart from this difference, all other fields are in perfect agreement with the RTP standard as in RFC3550. Moreover, all packets received by this endpoint have 172B of UDP payload, which is typical of VoIP streams using the ITU-T G.711 encoder [13] used in the FastWeb network. We then claim that this is an *actual* RTP flow, but the DPI oracle was fooled by the wrong version value. On the contrary, KISS correctly classifies this flow as a RTP flow.

Similarly, investigating the samples that are misclassified as DNS (e.g., from 15:30 to 16:00) we notice that a single endpoint (listening to UDP port number 9940) is the only responsible for this behavior. We manually inspected this traffic and verified that it cannot be a DNS endpoint, so that the oracle is reliable. Interestingly, no sample of this endpoint is included in the training set of Background traffic. Since the SVM is always forced to classify the sample as one of the possible classes, it resolves to classify it as DNS rather than Background. Considering this endpoint only, Fig. 6 shows

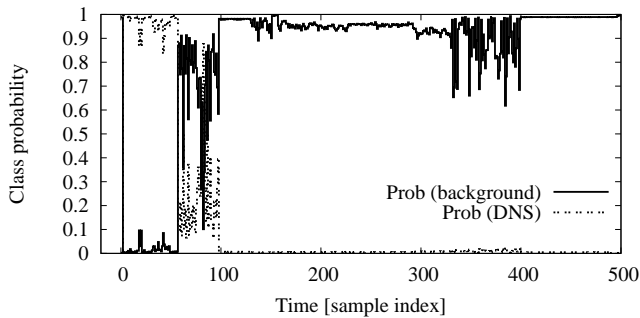

Fig. 6. Example of an endpoint that causes False Positives. Different classification windows over time.

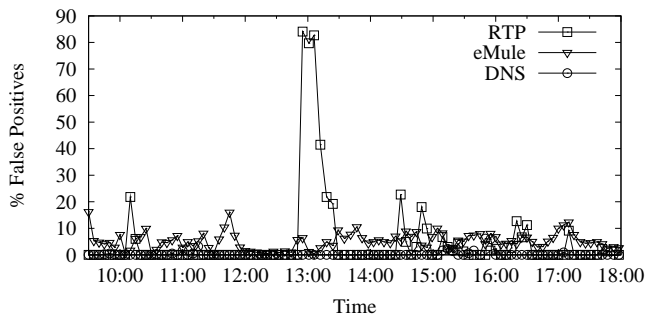

Fig. 7. False Positive percentage variation versus time. Aggregate in the training set.

the probability that the SVM evaluates it as a Background or DNS sample versus time. It can be seen that some uncertainty is present. Repeating the experiment by including some of these endpoint signatures in the Background training set, KISS correctly classifies it. This is an example of “under-training” of SVM.

Similar conclusions can be drawn investigating the eMule False Positives. They all correspond to endpoints listening to UDP port number 3074, possibly related to the Xbox-Live protocol, which is sometimes confused by the SVM as eMule traffic, since the SVM is “under-trained”. Also in this case, by adding some samples of these endpoints to the training set, no FP is detected.

We can conclude that KISS shows excellent performance, since in all cases the True Positive percentages are higher than 99%. The training of the SVM is robust considering the signature of known protocols, but it can suffer when the Background training set is small or does not include all protocols that may be present in the considered network scenario. This leaves room for improving the performance of KISS by carefully selecting the training set samples. Notice that the accuracy of any supervised machine learning decision process is strongly affected by the coverage and accuracy of the training set. Intuitively, a limited or outdated training set performs worse than an updated one. A discussion of the training set size and its impact on performance is presented in Sec. V.

#### D. Training with the Aggregate

A possible weakness of KISS is that the SVM must be trained with the Background traffic, i.e., with actual traffic extracted from the network the classifier is used representing the *Unknown* protocols. While the adoption of actual traffic does not pose particular issues, the extraction of “pure” Background is very questionable. A possible solution to this issue is to use, during the SVM learning phase, the whole *Aggregate* of traffic as *Unknown* traffic. This poses some problems, since samples of a given class may be part of the *Aggregate* traffic as well.

Fig. 7 shows results obtained by running KISS in the scenario previously described, but using the *Aggregate* trace to train the SVM for the *Unknown* traffic. Also in this case the True Positive percentage remains higher than 99% (results are not plotted for the sake of brevity). Considering FP, apart from the RTP endpoint that the oracle misclassifies, we observe an increased percentage of samples being classified as eMule (with an average %FP=4.5%). Nonetheless, results remain very good.

#### E. Training set size

Similarly, it is interesting to observe how performance changes with training sets of different size. Results are plotted in Fig. 8, which reports the %TP and %FP for increasing training set size with confidence intervals evaluated over 10 independent tests and accuracy  $\alpha = 0.5$ . The plot shows that KISS classifies RTP, DNS and eMule correctly starting from a training set size of only 25 samples (worst case is %TP>91.73% for DNS) but at least 75 samples are needed to obtain excellent results. Also in this case, the correct classification of the Background traffic is more problematic, since the False Positive percentage is smaller than 5% only when the training set comprises at least 200 samples. The intuition behind this is that the Background traffic is far more heterogeneous with respect to traffic of a given protocol and a larger number of samples are required to accurately describe it.

#### F. Training with many classes

All the results reported so far consider only 3 or 4 protocols. It is interesting to analyze the performance of the classifier with a larger number of target protocols. Using RealTrace-II, P2P-TV testbed and the Skype datasets we create a KISS model including nine different classes, plus one for the Background traffic. Each class has been characterized with 300 signatures randomly chosen from the initial portion of each trace. Tab. V reports the confusion matrix of the classification result. As before, labels on the rows represents the ground truth. The first column reports the total number of signature, while the other columns show the agreement between the ground truth and KISS classification. Again, results are impressive: KISS always achieves more than 99% of True Positives, with less than 10% of False Positives from the background class. Further analysis revealed that 7.59% of the false eMule samples are related to a single endpoint, which generates lots of short flows directed to an high number



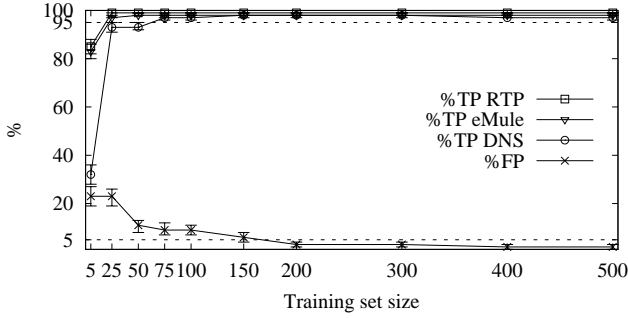

Fig. 8. Classification accuracy versus training set size.

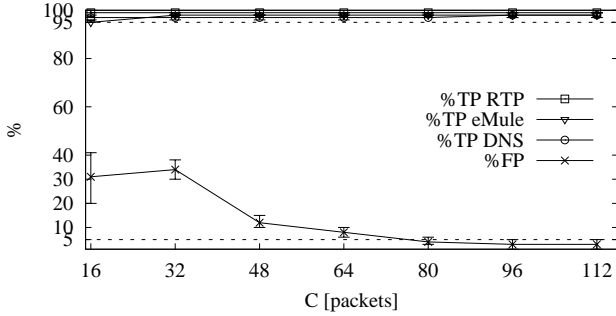

Fig. 9. Classification accuracy versus signature packet window  $C$ .

of different destinations. Unfortunately, we were not able to identify which actual protocol was used. After the adding of some samples of this endpoint in the background training set, all eMule False Positives disappeared. For what concern the 2.67% of samples identified as RTP, more than the 90% of them is generated by only two endpoints that use a RTP protocol with wrong version number as previously discussed in Sec. V-C.

### G. Parameter Selection And Tuning

The signature creation approach previously presented is based on a number of parameters whose setting may be critical. These are the criteria we used to set them:

**Bits per group,  $b = 4$ .** The choice of  $b$  should trade-off two opposite needs. On the one hand, we would like  $b$  to be the closest as possible to typical length of protocol fields; since protocols dialogs are usually based on words whose length is multiple of the byte or, sometimes, is half of a byte,  $b$  should be 4 or 8 or a multiple of 8. On the other hand,  $b$  should be small enough to allow that the packet window  $C$  over which the Chi-Square test is statistically significant is not too large. Beside, in this case streams can be classified even if they are not too long, they are classified in short time and live classification is possible. Thus, we chose  $b = 4$ .

**Number of bytes per packet,  $N = 12$ .** In general, classification accuracy increases with the number of considered bytes per packet. However, complexity of the classification tool increases also with  $N$ , in terms of both memory and computational complexity: as a convenient trade-off, we choose

$N = 12$ . Given  $b = 4$  this values corresponds to  $G = 24$  groups. Another reason to choose  $N = 12$  bytes is that, this way, we collect 20 bytes of the IP packet payload (12 bytes + 8 bytes of the UDP header) that is the minimum size of the TCP header and the typical value used by measurement tools. Notice that the optimal value of  $N$  depends on the targeted applications. For example, DNS and eMule can be clearly identified by only considering  $(X_2, X_3)$  as early showed in Fig. 2. However, when considering different protocols, possibly more and different groups must be considered. The selection of which is the best set of groups to include in the signature  $\bar{X}$  is then a complex task that is left out as future work.

**Packet window,  $C = 80$ .** While we would like to keep the packet window as small as possible, the estimation of the observed distribution is considered to be statistically significant if the number of samples for each value is at least 5. Having chosen  $b = 4$ , in order to have  $E_i = C/2^b$  equal to 5, we need  $C$  to be equal to about 80.

However, since in KISS we are not performing a real Chi-square test, we are interested in the impact of smaller values of  $C$ , which would allow an earlier classification. Fig. 9 reports the True Positive percentages of well-known protocols and the False Positive percentages, without distinguishing among protocols. Confidence intervals with an accuracy  $\alpha = 0.5$  are evaluated over 250 different sub-traces from RealTrace-I, each comprising more than 100 samples. The Figure clearly shows that the %TP is almost not affected by the number of samples that are considered to evaluate the observed frequencies in Eq. (1). Indeed, the format of the considered protocols is very different and the SVM has little problem in distinguishing them even if  $C$  is small. However, the %FP is much more sensitive to  $C$ , and only for  $C > 80$  it goes below 5%.

### H. Coverage

The packet window size  $C$  plays an important role in KISS design and it may affect the applicability of KISS. Indeed, given the connectionless characteristic of UDP, one expects that UDP flows and endpoints last for few packets. Fig. 10 confirms this intuition reporting the Cumulative Distribution Function (CDF) of flow length for both flow/endpoint packets and bytes. All incoming UDP traffic in RealTrace-I is considered to derive the CDF. The left plot clearly shows that 40% of flows and endpoints has only 1 packet, while only 0.2% of flows and 5% of endpoints have at least 80 packets. However, these flows/endpoints respectively account for more than 93.8% and 98.6% of the *bytes* carried by UDP, as reported in the right plot. This clearly shows that, while KISS is not suitable for the classification of short lived UDP flows/endpoints, it can however successfully target the small fraction of them that generate the majority of the traffic, i.e., long-lived flows.

### I. Complexity

KISS has limited computational complexity. In terms of memory,  $2^b$  counters are needed per group, giving a total of  $G \cdot 2^b$  counters for each tracked stream. Considering bitwise

TABLE V  
CONFUSION MATRIX CONSIDERING P2P-TV, REAL-TRACES AND SKYPE TRAFFIC

	Tot.	BitTorrent	eMule	RTCP	RTP	DNS	Skype	SopCast	TVAnts	PPLive	Backg
BitTorrent	1268	100	-	-	-	-	-	-	-	-	-
eMule	57255	0.02	99.15	-	-	0.03	-	-	-	-	0.80
RTCP	2407	-	-	99.96	-	-	-	-	-	-	0.04
RTP	585647	-	-	-	99.79	-	-	-	-	-	0.21
DNS	2707	0.46	-	-	-	99.54	-	-	-	-	-
Skype	46600	-	-	-	-	-	99.61	-	-	-	0.39
Sopcast	83460	-	-	-	-	-	-	99.95	-	-	0.05
TVAnts	25748	-	-	-	-	-	-	-	99.69	-	0.73
PPLive	27278	-	-	-	-	-	-	-	-	99.24	0.76
Backg	84273	0.27	7.59	-	2.67	0.22	-	-	-	-	89.25

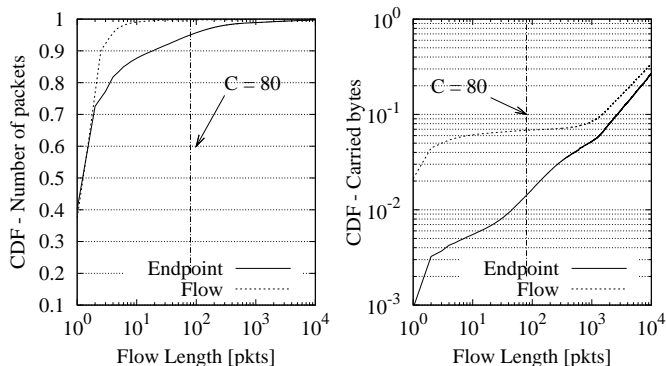

Fig. 10. CDF of the flow/endpoints length in packets (on the left), and bytes (on the right). The vertical line is in correspondence of 80 packets.

counters,  $G = 24$  and  $b = 4$ , 384 Bytes are required for each flow, i.e., a Gigabyte of memory allows to track more than 2.7M of streams.

The computation complexity of updating a  $\bar{X}$  signature involves  $G = 24$  increments for each packet. Once every  $C = 80$  packets, the signature is computed. The cost of this computation is  $O(G \cdot 2^b)$  multiplications, see Eq. (2).

The computational complexity of the SVM decision corresponds to some products between vectors, i.e., it has a complexity of  $O(G \cdot M)$  multiplications, being  $M$  the number of classes. Using the LIBSVM library it takes around 100  $\mu$ s to classify a signature from empirical measurements on an Linux system with an Intel(R) Core(TM)2 T8300@2.40GHz. Considering a single UDP flow, KISS can roughly classify  $8 \cdot 10^5$  packets/s; thus, on-line classification is possible for a 256Mbps stream of minimum-size UDP packets, even with no code optimization or parallelization.

## VI. RELATED WORK

Since **Port-based** classification [1] has become unreliable, a number of different solutions and methodologies have been proposed to classify Internet Traffic [4], [5], [9], [17], [18], [19], [20], [21], [22], [23], [24], [25]. Classification engines can be coarsely divided into three categories, each of them exploiting different ideas. For a good survey see [8] while [26] is a complementary work for the survey.

**Payload-based** techniques [9], [18], [19], [20] inspect the content of packets looking for distinctive signatures that allow to recognize a given application. All DPI techniques fall in this class.

**Machine-learning-based** classification [5], [21], [22], [23], [27], [28] rely on the rationale that, since the nature of the services is extremely diverse (e.g., Web vs VoIP), the corresponding generated traffic is very diverse as well (e.g., short-lived bursts of big packets versus long-lived, constant bitrate flows of small packets). This class of work stems from the characterization and modeling research field, which started from pioneering work [29]. Initial work in this area focused on the offline traffic classification, exploring which flow properties and which classification technique was best suited to discriminate traffic flows according to the different classes of applications [5], [21], [22], [23]. More recently, [27], [28] addressed the problem of “early” classification of individual applications, basing solely on information such as the size, direction (and inter-packet gap in case of [28]) of the very first packets of each flow: the initial handshake phase of different applications is distinctive and can be used as protocol fingerprint (e.g., SMTP handshake is different from HTTP one).

Finally, **Behavioral-based** classification [4], [24], [25] target the classification of Internet hosts on the sole basis of the transport layer traffic patterns they generate (e.g., P2P hosts contacts many different hosts typically using a single port, whereas a Web server is contacted by different clients with multiple parallel connections).

Our work aims at fine-grained classification of Internet traffic. As such, we consider work targeted to host identification [4], [24], [25] or to coarse-grained identification [5], [21], [22] to be not suited as a comparison for our purpose. Moreover, this work aims at filling a gap in the current Internet classification spectrum, specifically addressing UDP traffic classification. Since UDP is a connectionless protocol, we argue that approach such as [27], [28] cannot be applied as no handshake can be reliably identified in this case. Indeed, even the notion of “flow” is fuzzy considering UDP streams.

Works closest to ours are those that belong to the payload-based class. However, our work is very different from [9], [18], since the definition of application signatures does not rely on any reverse engineering of the applications. Instead, our approach is more similar in spirit to [19], [20], in which

authors automate the extraction of signatures from the application payload. Both [19], [20] rely on signatures extracted from the beginning of each data stream (more specifically, the first 64–256 bytes). We remove this assumption, so that the classification can start at any point in a flow. This is an important difference, since, for example, it opens the door to adopt packet sampling to cope with the ever increasing link data rate.

Another significant difference consists in the technique used to express the payload fingerprint: [19] uses discrete byte encoding, whereas the framework of [20] proposes the use of different models of increasing complexity. Another difference consists in the technique explored to perform the classification: indeed, in this work we use Support Vector Machines (SVM) which, to the best of our knowledge, has not yet been deeply tested in the context Internet traffic classification.

## VII. CONCLUSIONS

We presented KISS, a novel classifier explicitly targeting UDP traffic that couples the stochastic description of application protocols with the discrimination power of Support Vector Machines. Signatures are extracted from a traffic stream by the means of Chi-square like test that allows application protocol format to emerge, while ignoring protocol synchronization and semantic rules. A decision process based on Support Vector Machine is then used to classify the extracted signatures, leading to exceptional performance.

Performance of KISS has been tested in different scenarios, considering both data, VoIP, traditional P2P applications and novel P2PTV systems. Results are astonishing. The average True Positive percentage is 99.6% and less than 1% of False Positives are typically detected. Moreover, KISS is very robust to internal parameter setting and it is efficient both considering memory and computational requirements.

## REFERENCES

- [1] T. Karagiannis, A. Broido, N. Brownlee, K.C. Claffy, M. Faloutsos, "Is P2P dying or just hiding?," *IEEE GLOBECOM '04*, Vol.3, No., pp. 1532-1538, November 2004.
- [2] D. Bonfiglio, M. Mellia, M. Meo, D. Rossi, P. Tofanelli, "Revealing Skype Traffic: when Randomness Plays with You," *ACM SIGCOMM*, Kyoto, JP, August 2007.
- [3] A. Finamore, M. Mellia, M. Meo, D. Rossi, "KISS: Stochastic Packet Inspection", *1st Traffic Monitoring and Analysis (TMA) Workshop*, Aachen, 11 May 2009.
- [4] T. Karagiannis, K. Papagiannaki, M. Faloutsos "BLINC: multilevel traffic classification in the dark," *ACM SIGCOMM Computer Communication Review*, Vol. 35, No. 4, pp. 229-240, 2005.
- [5] A. W. Moore, D. Zuev, "Internet traffic classification using bayesian analysis techniques," *ACM SIGMETRICS*, Banff, Canada, pp. 50-60, June 2005.
- [6] N. Cristianini, J. Shawe-Taylor, "An introduction to support Vector Machines and other kernel-based learning methods," *Cambridge University Press*, New York, NY, 1999.
- [7] M. Mellia, R. Lo Cigno, F. Neri, "Measuring IP and TCP behavior on edge nodes with Tstat," *Computer Networks*, Vol.47, No.1, pp. 1-21, January 2005.
- [8] T. Nguyen, G. Armitage, "A Survey of Techniques for Internet Traffic Classification using Machine Learning" *IEEE Communications Surveys and Tutorials*, vol. 10 no. 4, 2008.
- [9] A. W. Moore, K. Papagiannaki, "Toward the Accurate Identification of Network Applications," *In Passive and Active Measurement (PAM'05)*, Boston, MA, USA, March/April 2005.
- [10] C. C. Chang, C. J. Lin, "LIBSVM: A library for support vector machines," Available at <http://www.csie.ntu.edu.tw/~cjlin/libsvm>, 2001.
- [11] Skype Testbed Traces. Available at <http://tstat.tlc.polito.it/traces-skype.shtml>
- [12] "FastWeb Company Information", <http://company.fastweb.it>, 2006.
- [13] R. Birke, M. Mellia, M. Petracca, D. Rossi, "Understanding VoIP from Backbone Measurements", *IEEE INFOCOM 2007*, Anchorage, Ak, May 2007.
- [14] E. Leonardi, M. Mellia, A. Horvart, L. Muscariello, S. Niccolini, D. Rossi, "Building a Cooperative P2P-TV Application over a Wide Network: the Approach of the European FP-7 STREP NAPA-WINE", *IEEE Communications Magazine*, Vol. 46, pp. 20-211, April 2008.
- [15] "IPP2P home page", Available at <http://www.ipp2p.org/>.
- [16] Y. Kulbak, D. Bickson, "The eMule protocol specification," *Technical Report Leibniz Center TR-2005-03*, School of Computer Science and Engineering, The Hebrew University, 2005.
- [17] C. Dewes, A. Wichmann, A. Feldmann, "An analysis of Internet chat systems," *3rd ACM SIGCOMM Internet Measurement Conference (IMC'03)*, Miami Beach, FL, pp.51-64, October 2003.
- [18] S. Sen, O. Spatscheck, D. Wang, "Accurate, scalable in-network identification of p2p traffic using application signatures," *13th International Conference on World Wide Web (WWW'04)*, pp. 512-521, New York, NY, May 2004.
- [19] P. Haffner, S. Sen, O. Spatscheck, D. Wang, "ACAS: automated construction of application signatures," *ACM SIGCOMM Workshop on Mining Network Data (Minenet'05)*, pp. 197-202, Philadelphia, PA, August 2005.
- [20] J. Ma, K. Levchenko, C. Kreibich, S. Savage, G. M. Voelker, "Unexpected means of protocol inference," *6th ACM SIGCOMM Internet Measurement Conference (IMC'06)*, pp. 313-326, Rio de Janeiro, BR, October 2006.
- [21] A. McGregor, M. Hall1, P. Lorier, J. Brunskill, "Flow Clustering Using Machine Learning Techniques", *PAM 2004*, Antibes Juan-les-Pins, Fr., pp. 205-214, April 2004.
- [22] M. Roughan, S. Sen, O. Spatscheck, N. Duffield, "Class-of-service mapping for QoS: a statistical signature-based approach to IP traffic classification," *4th ACM SIGCOMM Internet Measurement Conference (IMC'04)*, Taormina, IT, pp. 135-148, October 2004.
- [23] J. Erman, M. Arlitta, I. Cohen, C. Williamson, "Offline/realtime traffic classification using semi-supervised learning", *Performance Evaluation*, Vol. 64, No. 9-12, pp. 1194-1213, October 2007.
- [24] T. Karagiannis, A. Broido, M. Faloutsos, K. Claffy, "Transport layer identification of P2P traffic," *4th ACM SIGCOMM Internet Measurement Conference (IMC'04)*, Taormina, IT, pp. 121-134, October 2004.
- [25] K. Xu, Z. Zhang, S. Bhattacharyya, "Profiling internet backbone traffic: behavior models and applications," *ACM SIGCOMM 2005*, Philadelphia, PA, pp. 169-180, August 2005.
- [26] H. Kim, K.C. Claffy, M. Fomenkov, D. Barman, M. Faloutsos, K. Lee, "Internet traffic classification demystified: myths, caveats, and the best practices" *Conference on Future Networking Technologies (CoNEXT'08)*, Madrid, Spain, December 2008.
- [27] L. Bernalle, R. Teixeira, K. Salamatian, "Early Application Identification," *Conference on Future Networking Technologies (CoNEXT'06)*, Lisboa, PT, December 2006.
- [28] M. Crotti, M. Dusi, F. Gringoli, L. Salgarelli, "Traffic Classification through Simple Statistical Fingerprinting," *ACM SIGCOMM Computer Communication Review*, Vol. 37, No. 1, pp.5-16, January 2007.
- [29] V. Paxson, "Empirically derived analytic models of wide-area TCP connections," *IEEE/ACM Transactions on Networking*, Vol. 2, No. 4, pp. 316-336, August 1994.



**Alessandro Finamore** (S'09) received the M.Sc. in computer engineering in 2008 at Politecnico di Torino. Between 2008-2009 he has been research assistant at Politecnico di Torino, while from 2009 he joined the Telecommunication Network Group at Politecnico di Torino as Ph.D. student.

His research interests are traffic classification and computer programming.



**Marco Mellia** (SM'08) received his Ph.D. degree in Telecommunications Engineering in 2001 from Politecnico di Torino. In 1999, he was with the CS Department at Carnegie Mellon University, Pittsburgh (PA) and since April 2001 he is with EE Department of Politecnico di Torino. He has co-authored over 140 papers published in international journals and conferences, and he participated in the program committees of several conferences including IEEE Infocom and ACM Sigcomm. His research interests are in the fields of traffic measurement, P2P

applications and energy aware network design.



**Michela Meo** (M'02) received the Laurea degree in electronic engineering in 1993 and the Ph.D. degree in electronic and telecommunication engineering in 1997, both from Politecnico di Torino, Italy. Since November 1999, she is an Assistant Professor at Politecnico di Torino. She co-authored more than 100 papers, about 40 of which are in international journals. She edited six special issues of international journals, including ACM Monet, Performance Evaluation Journal and Computer Networks. Her research interests are in the field of performance

evaluation and modeling, traffic classification and characterization, peer-to-peer, green networking. Dr. Meo was program co-chair of two editions of ACM MSWiM, general chair of another edition of ACM MSWiM, program co-chair of IEEE QoS-IP, IEEE MoVeNet 2007, IEEE ISCC 2009 and she was in the program committee of about 50 international conferences, including Sigmetrics, Infocom, ICC, and Globecom.



**Dario Rossi** (M'02) received his Ph.D from Politecnico di Torino in 2005. During 2003/2004 he was with the CS Department at University of California, Berkeley. Since October 2006, he is an Associate Professor at Telecom ParisTech, Paris. He has co-authored over 40 papers in leading conferences and journals. He participated in the program committees of several conferences like IEEE ICC, IPCCC and Globecom. His research interests include P2P networks, Internet traffic measurement, sensor and vehicular networks.